

To protect your METTLER TOLEDO product's future:  
METTLER TOLEDO Service assures the quality, measuring accuracy and  
preservation of value of all METTLER TOLEDO products for years to come.  
Please send for full details about our attractive terms of service.  
Thank you.



Subject to technical changes and to the availability  
of the accessories supplied with the instruments.

© Mettler-Toledo GmbH 1998 11780209A Printed in Switzerland 9807/2.12

Mettler-Toledo GmbH, Laboratory & Weighing Technologies, CH-8606 Greifensee, Switzerland  
Phone +41-1-944 22 11, Fax +41-1-944 30 60, Internet: <http://www.mt.com>

## Operating instructions

### METTLER TOLEDO AT balances

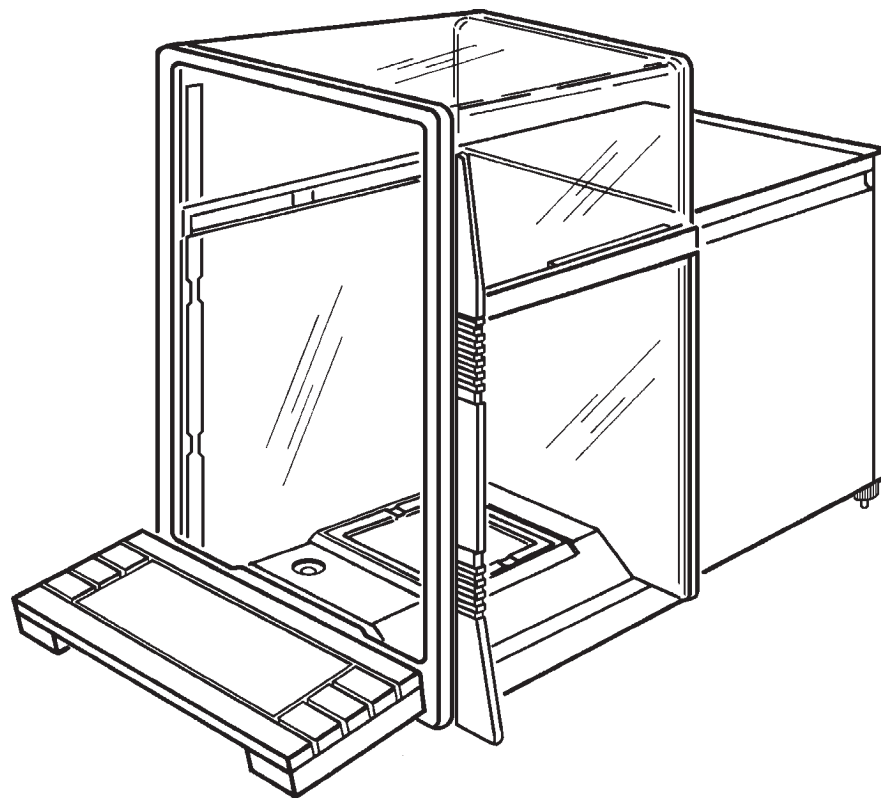

Operating instructions METTLER TOLEDO AT balances

Thank you for purchasing a METTLER TOLEDO AT analytical balance.  
The AT balances combine a wide range of weighing and setting options with an exceptional ease of operation.

Please read these operating instructions through carefully so that you can utilize all possibilities offered by your AT balance to the full. These operating instructions also offer valuable support in the form of a glossary and an index.

The present operating instructions apply to all METTLER TOLEDO balances of the AT series. As the various models have different performance characteristics, however, special mention is made in the text where this is important for the operation.

Please read through the enclosed booklet "Weighing the right way". It is intended as a supplement to these operating instructions and contains additional important tips and informations.

If you fold out this page, you will have an overview of your AT balance that shows you all features at a glance.

#### Safety has priority



- It is essential you consult the instructions in section 1.2 regarding putting your new balance into operation.
- The AT balances may be operated when connected to receptacle outlets with a ground connection.
- The AT balances must not be operated in hazardous surroundings.
- Never open the balance, it contains no parts which can be serviced, repaired or changed by the user. In the unlikely event you experience problems with your balance, please contact the responsible service facility.

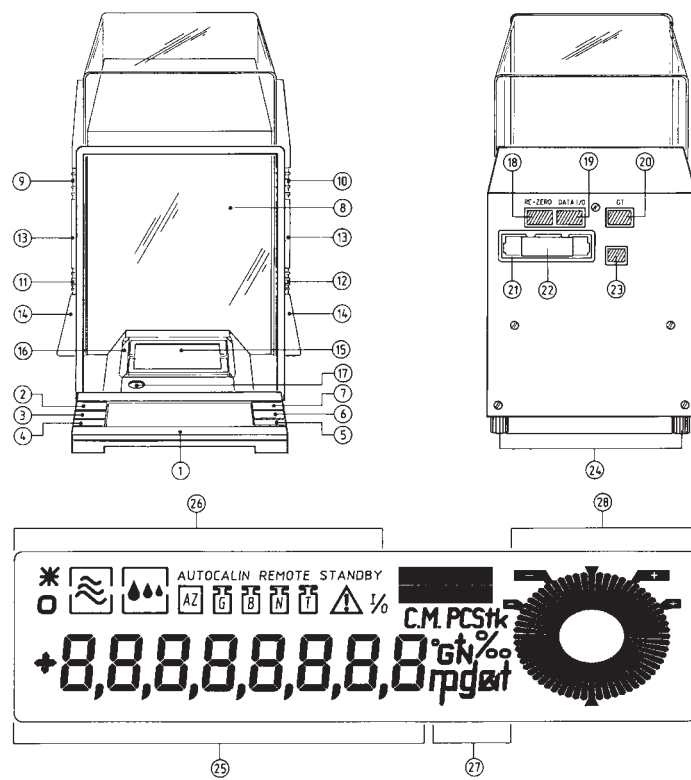

- 1 Key «Re-Zero», «Set», «On/Off»
- 2 Key «0.1/0.01 mg» (with dual-range balances only), «Cancel»
- 3 Key «Menu», «Configuration»
- 4 Key  $\updownarrow$  «Select 1»
- 5 Key  $\updownarrow$  «Select 2»
- 6 Key «Print»
- 7 Key
- 8 Glass draft shield
- 9 Coupling element
- 10 Coupling element
- 11 Coupling element
- 12 Coupling element
- 13 Door handle
- 14 Door drive handle
- 15 Weighing pan
- 16 Draft cover
- 17 Level
- 18 Connection for foot or hand switch and electrical contacts
- 19 Connection for data interface
- 20 Connection to overhead display
- 21 Plug-in slot for program cassette
- 22 Program cassette, protection of the configuration parameters
- 23 Connection for AC adapter
- 24 Screw feet
- 25 Digital display (VFD or LCD)
- 26 Status indicators
- 27 Weight units
- 28 DeltaTrac®

Operating instructions METTLER TOLEDO AT balances

## Contents

	Page		Page
<b>1 The AT smooths the way</b> .....	<b>1</b>	<b>5 Special applications and functions of your AT balance</b> .....	<b>40</b>
1.1 The new weighing feeling .....	1	5.1 Your AT can work with two weight units .....	40
1.2 Preparing your AT .....	2	5.2 Your AT also weighs in percent and displays plus/minus deviations .....	41
1.3 Weighing made simple .....	5	5.3 Should your AT count pieces? .....	43
<b>2 Your AT - a balance with extreme ease of operation</b> .....	<b>8</b>	5.4 How to trigger the adjustment manually .....	46
2.1 A glass draft shield with unlimited possibilities .....	8	5.5 How to check whether the balance is still adjusted correctly .....	49
2.2 The Mettler DeltaTrac - an informative display .....	11	5.6 How to print out the weighing result .....	51
2.3 Is your AT a Mettler DeltaRange balance? .....	11	5.7 Your AT can also be remote controlled .....	52
2.4 How you can weigh in the coarse and fine range .....	12	<b>6 Important information regarding your AT</b> .....	<b>53</b>
<b>3 Individual adaptation of your AT</b> .....	<b>14</b>	6.1 The AC adapter offers you various installation options .....	53
3.1 What is the menu? .....	14	6.2 If you change the location of your AT .....	55
3.2 How to adapt your AT to different types of weighing .....	17	6.3 A well maintained balance is a joy forever .....	56
3.3 How to adapt your AT to the local conditions .....	19	6.4 What your AT brings with it .....	57
3.4 How to switch off the fully automatic door function .....	20	6.5 Additional information and accessories for your AT balance .....	57
<b>4 Additional possibilities in the configuration register</b> .....	<b>22</b>	<b>7 Any questions?</b> .....	<b>58</b>
4.1 What is the configuration register? .....	22	7.1 What happens if the weight display is unstable? .....	58
4.2 How is the configuration register used? .....	23	7.2 How can the weighing speed be increased? .....	61
4.3 In the first sector you return to the factory setting .....	26	7.3 What happens if...? .....	62
4.4 The second sector offers you numerous adaptation possibilities .....	27	7.4 What does this error message mean? .....	66
4.5 In the third sector you select the weight units and additional settings .....	32	7.5 What does this term mean? .....	67
4.6 In the fourth sector the AT reveals itself as a balance ready to communicate .....	35	7.6 How are weight units converted? .....	78
4.7 Print out the current configuration .....	38	7.7 Where will I find details of...? .....	80
4.8 How to protect your settings against inadvertent changes .....	39	Technical specifications .....	84

Operating instructions METTLER TOLEDO AT balances

Operating instructions METTLER TOLEDO AT balances

# 1 The AT smooths the way

## 1.1 The new weighing feeling

Your AT balance offers a wide range of functions, yet is simple to operate.

For example, there is no need whatever to concern yourself with the adjustment - your AT performs the adjustment fully automatically. Your AT is equipped with an adjustable glass draft shield with a fully automatic door function. Just two examples to give you a preview of the full range of equipment of your new balance.

Your AT balance is distinguished primarily, however, by its user friendliness. You set the balance up, connect it to the power supply and after a few minutes warm-up time you can immediately start weighing. You thus obtain your first weighing result in the shortest time possible.

The AT offers you the operating convenience and the complete range of options you expect from a top-quality analytical balance. There is, however, no need for you to grapple at the moment with functions you will not need until later.

In this first section you will find out how simply you can start up your AT and perform normal weighings.

## 1.2 Preparing your AT

If you fold out the front fold-out, you have in front of you an immediate overview of all general illustrations at a glance.

You need undertake the following operations only on first-time installation and each time you change the balance location.

### Select a suitable location

Your AT expresses its thanks for an optimum location by providing you with excellent weighing results:



- Firm, vibration-free location, as level as possible

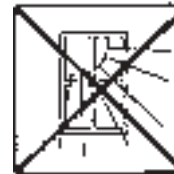

- No direct sunlight



- No extreme temperature fluctuations



- No excessive drafts (e.g. through powerful air conditioning)

Additional tips and information regarding an optimum location can be found in the METTLER TOLEDO brochure - **“Weighing the right way”**, which is enclosed with your balance.

### How you can transport the balance

When you position your AT balance at its location, please note the following:

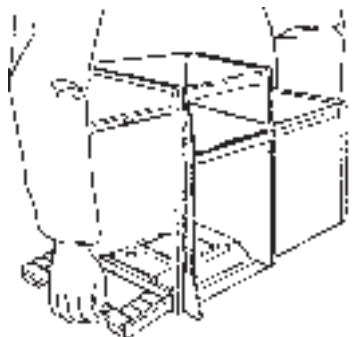

To transport the balance, hold it at the front under the display and at the rear beneath the balance housing. Never lift your AT using the draft shield or the «Re-Zero» key!

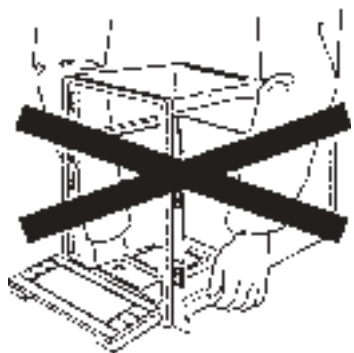

### Mount the draft cover and level the balance

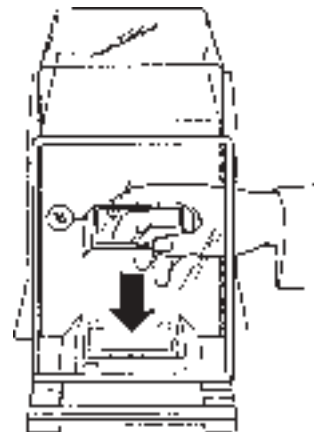

- Place the draft cover **16** supplied separately in position. When positioning the draft cover, ensure that it is not touched by the weighing pan, which must move freely in its recess. If necessary, turn the weighing pan to the correct position. The draft cover is useful primarily for balances with the semimicro range (readability 0.01 mg). In many cases it need not be installed in weighings in the analytical range (readability 0.1 mg).

As an option, semimicro balances can be equipped with an additional inner draft shield whose installation is described in the enclosed mounting instructions.

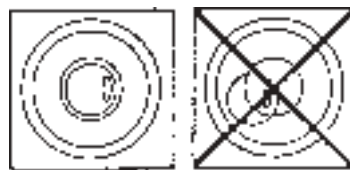

- Turn the two screw feet **24** at the rear of the balance housing until the air bubble is in the middle of level **17**.

## Prepare the glass draft shield

The draft shield of your AT balance comprises several parts which can be combined in a number of ways using the coupling elements. To preclude transport damage, these coupling elements are not locked in position when shipped. Connect the individual parts of the draft shield as follows:

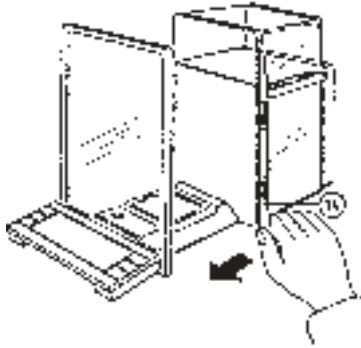

- Pull all doors of the draft shield and the opposing door holder **14** forwards as far as possible.

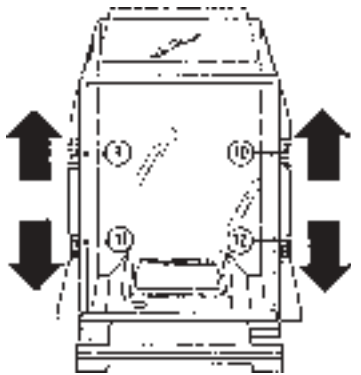

- Push the two upper coupling elements **9** and **10** upward and the two lower coupling elements **11** and **12** downward until they lock.

When in this position, the whole draft shield opens. Additional combination possibilities of the individual doors are described in Section 2.1.

## Connect your AT to the power supply

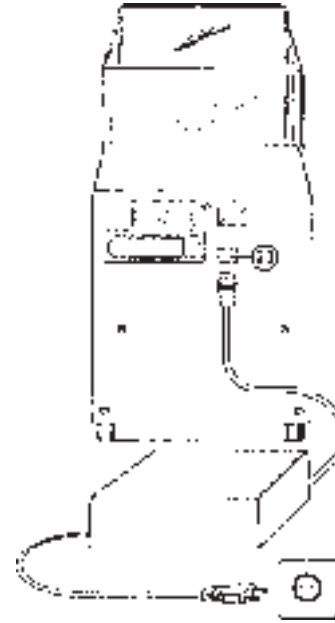

- Connect the AC adapter supplied to connection socket **23** at the rear of your AT balance and then to the power supply.
- The AC adapter can either be placed on the bench, attached to the balance or, to save space, be mounted on the wall. The AC adapter holder and the installation set with dowels and screws are used for this. Appropriate details are given in Section 6.1.

STANDBY

After connection, your AT balance is on standby and ready for weighing after a brief warm-up time of about 5 minutes. (See also Technical specifications page 84).

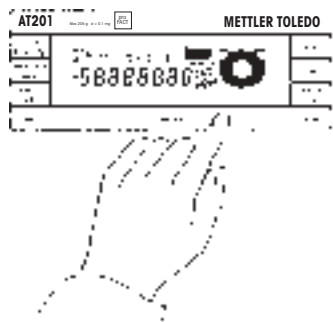

### 1.3 Weighing made simple

- By pressing the «On/Off» key you switch your AT from standby to the **weighing mode**. The balance now performs a brief self-test and all display segments light up briefly.
- If the draft shield is open, you can close it by pressing one of the two keys  $\updownarrow$ .

Your AT balance is fitted with a fully automatic door function, which ensures that the draft shield is always open or closed at the right time. Section 3.4 describes how you can switch off this automatic mechanism. On completion of the self-test, this function opens the draft shield completely automatically.

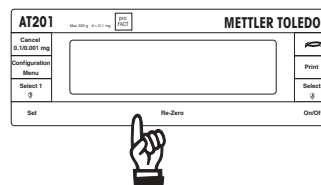

### Set your balance to zero (taring):

- If you wish to tare a container, place it on the balance.
- Press the «Re-Zero» key. The fully automatic door function closes the draft shield.

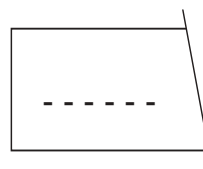
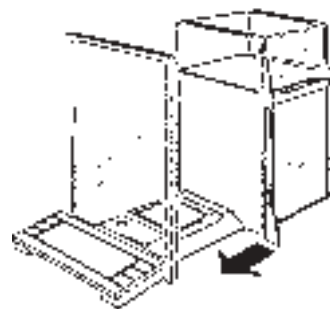

Zeroing of the display (taring) is automatic. While the zeroing is in progress and the horizontal segments appear in the display, you can abort the process by briefly pressing the «Re-Zero» key again.

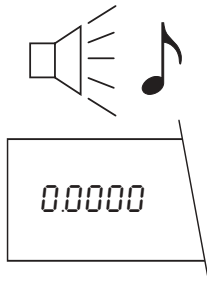

As soon as the warning beep sounds, zeroing of the balance is complete and the fully automatic door function opens the draft shield.

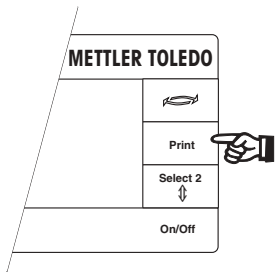

- Load the weighing sample and press the «Print» key. The fully automatic door function closes the draft shield.

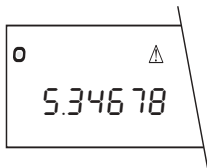

- The triangle symbol (print symbol) and the circle symbol of the stability detection (ASD) appear in the display.

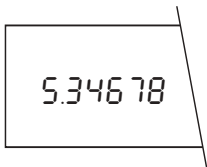

- When the symbol of the stability detector (ASD) fades, the warning beep sounds; the triangle symbol also fades and the draft shield opens automatically.  
**Note:** You can also open and close the draft shield with one of the keys  $\updownarrow$  or by hand.

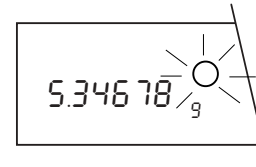

- Read off the weighing result. The result remains “frozen” on the display for 5 seconds. This can be recognized by the flashing circle above the weighing unit. If the balance is attached to a printer, the weighing result is automatically printed out.  
**With this automatic door function, your work steps in weighing are reduced from 9 to 5!** (You don't have to open and close the draft shield twice.)

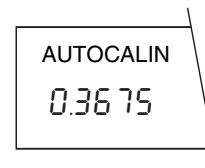

It is possible that the warning beep sounds during a weighing and the adjacent symbol appears in the display. Your AT balance uses this to show that it would like to adjust itself. But there is no need for you to interrupt your work as the balance waits until you have not carried out any weighings for a period of about 5 minutes and then performs the **fully automatic self-adjustment** (proFACT). The symbol remains lit up until the balance has adjusted itself or until you trigger the adjustment by a



keystroke. Section 5.4 shows you how to trigger the adjustment yourself.

- For **switching off the balance**, lift up the «**On/Off**» **key** briefly from below. This closes the draft shield automatically if the fully automatic door function is switched on. Otherwise, close the draft shield manually to prevent the ingress of dust and dirt.

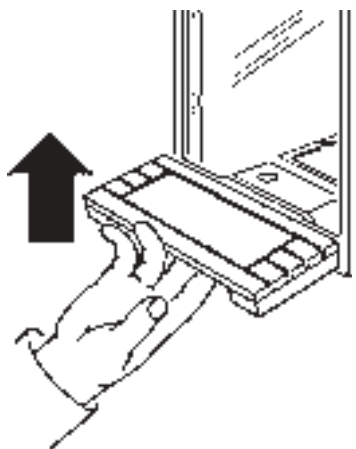

STANDBY

After being switched off, the balance is on **standby**. When it is switched on again, it needs no warm-up time and is in immediate operational readiness.

### Some additional tips:

- If you have made a mistake during weighing, there is no need to worry: Simply switch your AT off and then immediately on again. You will later learn of other possibilities to bring your AT to weighing readiness again.
- You can also effect the zeroing (taring) of the balance using the **foot or hand switch** (available as an accessory) attached to the balance via connection **18**. Operation with the foot switch leaves you both hands free for loading your AT.

- If you ever have to disconnect your AT from the power supply, first switch it off by lifting up the «On/Off» key. After the balance has been reconnected, it is in the standby mode and “*STANDBY*” appears in the display.

After an unexpected power outage, however, or if you have not switched off your AT before disconnecting it from the power supply, when power is restored again “*-OFF-*” appears in the display. When the «On/Off» key is now pressed, in this case an extended, internal self-test is first performed. Here the model designation and the software version are briefly displayed, and all display segments light up for a short space of time.

## 2 Your AT - a balance with extreme ease of operation

### 2.1 A glass draft shield with unlimited possibilities

With the glass draft shield you can adapt your AT balance to the local conditions (principally drafts), to your individual style of weighing, to the size of the tare containers, and to the type of weighing and loading.

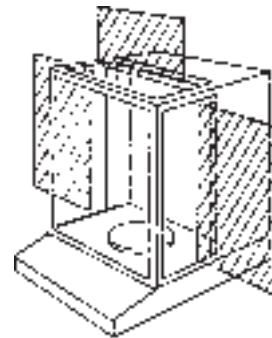

The fixed bars of a traditional draft shield prevent access to the weighing chamber.

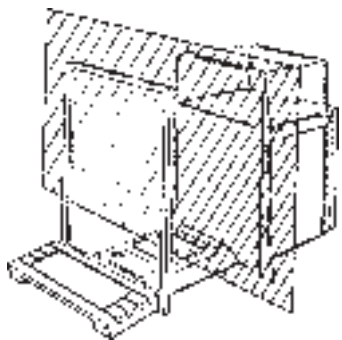

The draft shield of the AT balance has no fixed bars and the weighing chamber is freely accessible. Your AT is thus also especially well suited to automatic loading.

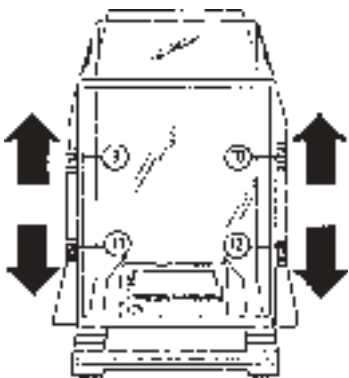

The **left, right and upper doors** of the draft shield can be **combined in any way** and hence matched to your weighing needs by means of the coupling elements **9 to 12**.

Try out various combinations by shifting the coupling elements upward and downward. For the manual door operation the coupling elements **11** and **12** must always be disengaged (top position)!

**When small weighing samples have to be loaded, we advise you to open only one of the two side doors. Your balance then operates quicker since the disturbing air currents are less than when more doors of the draft shield are open.**

You can operate the draft shield **manually** in the traditional manner.

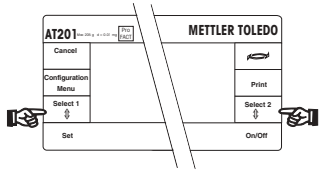

The **semiautomatic** operation can be effected either with the left or the right  $\updownarrow$  key. In this case, the draft shield is opened and closed by the motor.

In certain applications, such as zeroing (taring) of the balance, the draft shield opens and closes **fully automatically** as you already know from your first weighing. Manual or semiautomatic operation is also possible when the fully automatic door function is operative. The fully automatic door function primarily facilitates work with the single or twin foot switch. Section 3.4 shows you how to switch off the fully automatic door function.

A further tip: You will obtain the most accurate results in the quickest possible manner if you close the draft shield completely during weighing! If this is not possible, for instance with bulky weighing samples, you should combine the doors of the draft shield such that the greatest possible part of the draft shield remains closed during the weighing.

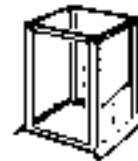

So that excellent weighing results can also be achieved fast under difficult weighing conditions, you can also use an inner draft shield. (Order number 210270)

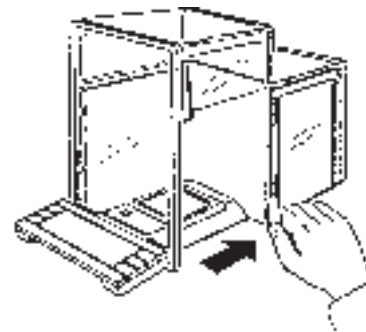

For loading the balance, open only as many doors as necessary. With relatively small weighing samples or rather small tare containers, it is normally sufficient to open a single door. This lessens the influence of drafts and speeds up the weighing process.

## 2.2 The DeltaTrac® - an informative display

The DeltaTrac® **28** is a supplement to the digital display **25**. It provides you with a pictorial representation of **the weighing range in use and that still remaining**. The dynamics of a weighing process can be followed on the DeltaTrac® extremely well. Simply observe the DeltaTrac® during a weighing and you will immediately understand its function.

The DeltaTrac® gives you a new feel for weighing, even with special applications, for example in repeated weighing in to a specified target value and in percent weighings. You will find further details in Section 5.2.

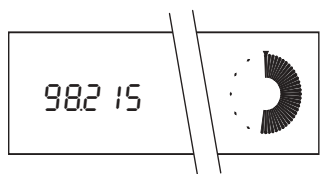
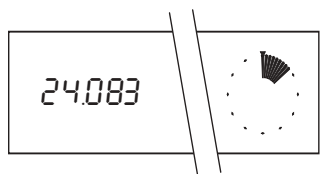

## 2.3 Is your AT a DeltaRange® balance?

The AT261 and AT460 models are DeltaRange® balances. They have a ten times more accurate, movable fine range, which shows an additional decimal place. Thus, for example, the AT261 has a resolution of 0.1 mg over the entire weighing range and a movable fine range with a resolution of 0.01 mg.

This fine range can be called up **at any point in the whole weighing range as often as liked**.

The movable fine range covers 62 g for both models. Each time you set the balance to zero (tare) with the «Re-Zero» key, the fine range is switched in. If the span of the fine range is exceeded, the balance automatically switches into the coarse range. The fine range can be called up again by rezeroing the balance once more using the «Re-Zero» key.

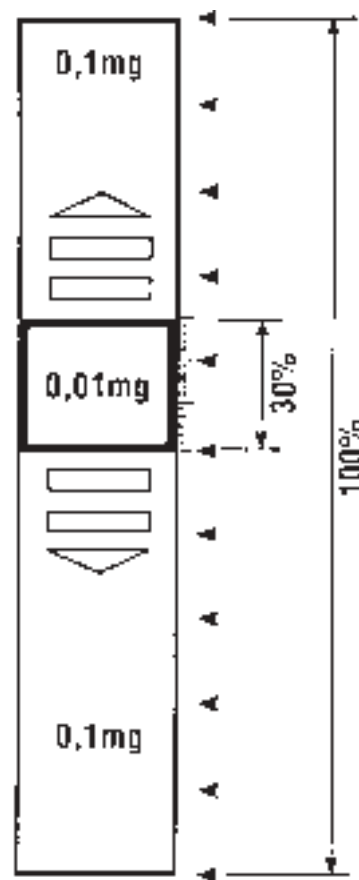

**Note:**

This ten times more accurate movable fine range also remains active in differential weighing.

## 2.4 How you can weigh in the coarse and fine range

Semimicro and DeltaRange® balances of the AT series are equipped with a switch key which you can use to switch from the coarse range to a ten times more accurate fine range.

The AT thus allows you to work in the range best suited to your needs.

If, for example, instead of a high resolution you need a stable weighing result as rapidly as possible, you switch from the fine range to the coarse range using the switch key. This makes your AT very fast and the weighing results are extremely stable.

You can thus also disable the DeltaRange® if you do not need it.

You have the following selectable ranges available:

Balance	Coarse range	Fine range	Key
AT20	0.01 mg	2 µg	10 / 2 µg
AT201	0.1 mg	0.01 mg	0.1 / 0.01 mg
AT261	0.1 mg	0.01 mg	0.1 / 0.01 mg
AT460	1 mg	0.1 mg	1 / 0.1mg

With the «0.1/0.01 mg» key (e.g. with AT201/AT261 DeltaRange®) you can switch between the coarse and the fine range:

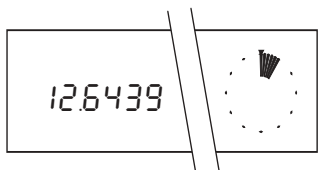

- The balance is measuring in the coarse range

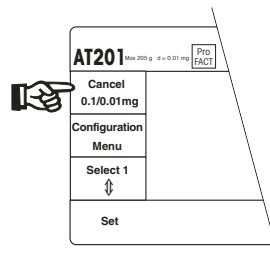

- Press the «0.1/0.01 mg» key (e.g. with AT201/AT261 DeltaRange®) and ...

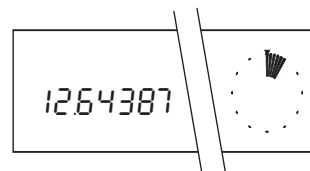

- ...the balance operates in the ten times more accurate fine range.

- By pressing the «0.1/0.01 mg» key again, you can return to the coarse range.

### 3 Your AT is an adaptable balance

For the optimization of your weighing results and adaptation to your weighing needs, the AT offers you additional setting options. You undertake these adaptations in the **menu**, which you will now be introduced to.

You can set additional parameters in the second menu tree of your AT, the configuration register (section 4).

#### 3.1 What is the menu?

In the menu you match your balance to the local conditions and to the weighing tasks. The menu contains various adaptation possibilities, the menu options, which in turn offer different setting options.

Overview of the menu functions:

- reference weight in %
- reference weight in pieces
- adjustment
- weighing process adapter
- vibration adapter
- fully automatic door function

**You will find a detailed overview of the menu on pages 82 and 83.**

In addition, you can also perform several operational steps in the menu for special applications (percent weighing and piece counting). Section 5 of these operating instructions provides you with more information.

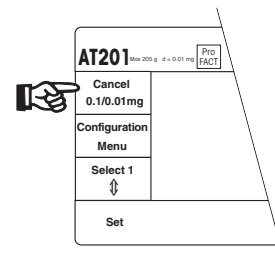

We encourage you to **experiment** with the menu to familiarize yourself with it. **You need have no worries here: By pressing the «Cancel» key you can return to the weighing mode at any time without changing the stored settings!**



You perform your weighings in the **weighing mode**, the operational mode of your balance. **Weighing mode** and **menu** are separate. By pressing and holding the «Configuration» key you can call up the configuration register. You can also select the different menu options and setting possibilities with keystrokes.

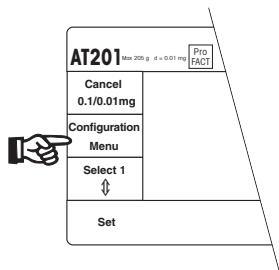

#### «Menu» key

- Selection of the **menu** by **briefly** pressing the key in the weighing mode
- Selection of the individual **menu options**

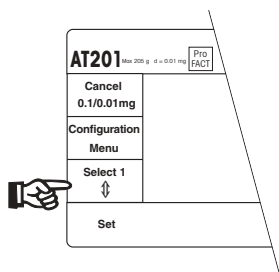

#### «Select 1» key

- Selection of the **setting** in a menu option

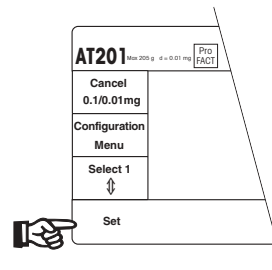

#### «Set» key

- **Confirmation** of your selection and return to the weighing mode. The selected settings are stored and remain so even after the balance has been switched off.

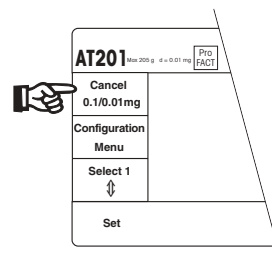

#### «Cancel» key

- **Exit** the menu and return to the weighing mode **without any changes** being made. If you have made a wrong selection, you can leave the menu **at any time** by pressing the «Cancel» key. You are then in the weighing mode again **without any change in the settings**. Instead of pressing the «Cancel» key, you can naturally switch the scale off and then on again.

By repeated pressing of the «Menu» key, all available menu options appear in the display in succession:

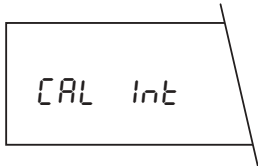

- proFACT  
fully automatic adjustment and linearization

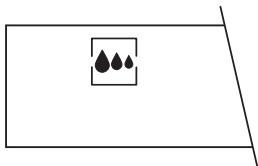

- Adaptation to the type of weighing  
(weighing process adapter)

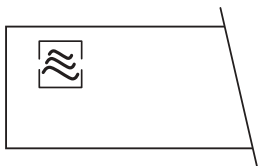

- Adaptation to the local conditions  
(vibration adapter)



- Automatic door function of the draft shield

A complete overview of the menu can be found on the pages 82 and 83.

### Some additional tips:

- Not all menu options are constantly or exactly displayed in the form shown; some of them, e.g. the setting of reference weights ("Set 100%") depend on additional settings in the configuration register, which we will introduce you to in Section 4 of these operating instructions.
- If you are in the menu and **press no key for about 1 minute**, the AT **returns automatically to the weighing mode**. Any changes in the settings made up to this point are ignored in this case.

- In the following 3 sections you will get to know the three menu options (weighing process adapter, vibration adapter and automatic door function) in detail. The additional setting options for special applications (weighing in reference weights for percent weighings or piece counting and the adjustment) will be introduced in Section 5.

## 3.2 How to adapt your AT to different types of weighing

Your AT balance can be matched to different types of weighing (fine dispensing, absolute weighing, etc.) very simply. It is equipped for this purpose with the so-called **weighing process adapter**, which can be set in the menu.

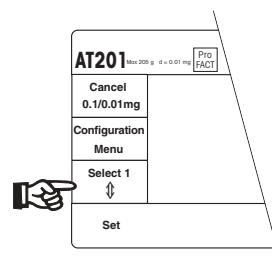
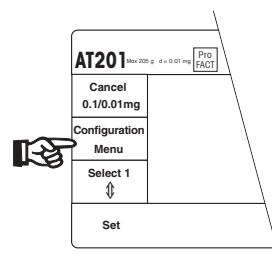

- Select the menu by pressing the «Menu» key briefly.
- Press the «**Menu**» key repeatedly until the drop symbol of the weighing process adapter appears in the display.
- Select the appropriate setting with the «**Select 1**» key:



This is the **universal setting** suitable in principle for all types of weighing. This setting is preset in the factory.



The position **absolute weighing** is suitable for the rapid checking of a weight. During the weighing in, the last decimal place is suppressed.



If you wish to employ fine dispensing (weighing in) of a fine powder or small amounts of liquid, select the **weighing in** position. This provides a continuous display of all decimal places, and the weight increase can thus be followed easily.



In this position the drop symbol is invisible, the weighing process adapter is switched off. This setting is **suitable only for special applications** in which not only the final result but also the dynamics of the weighing process are of interest, for example the recording of weight changes due to evaporation against time.

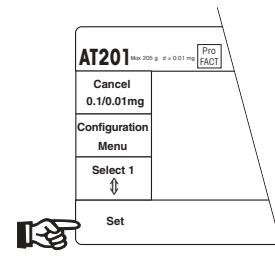

- When you have selected the appropriate setting, press the «**Set**» key. This makes the settings active immediately, and the balance returns to the weighing mode.

### 3.3 How to adapt your AT to the local conditions

For all weighings, we advise you always to open the draft shield only as far as necessary. You thus achieve stable weighing results as quickly as possible.

If, despite a closed draft shield, no stable weighing results are found, the cause could lie with unfavorable local conditions such as vibrations. Very minor, hardly noticeable vibrations of the weighing table are usually involved.

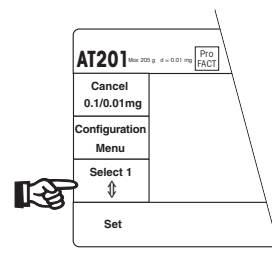
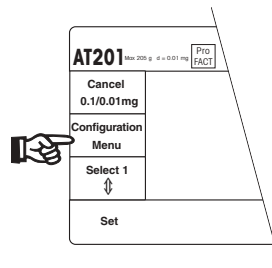

With the so-called **vibration adapter** your AT balance can be matched in the menu to the local conditions.

- Select the menu.
- Press the «**Menu**» key repeatedly until the wave symbol of the vibration adapter appears in the display.
- Select the appropriate setting with the «**Select 1**» key:



This setting is suitable for **normal ambient conditions**; the balance operates at **moderate speed** in this case. This position is set in the factory.



This setting is suitable for work in **unquiet surroundings**. The balance operates **more slowly**, but is less sensitive to external disturbances.



This setting is suitable for **very quiet and stable surroundings**. The balance operates **very rapidly**, but is relatively sensitive to external disturbances.

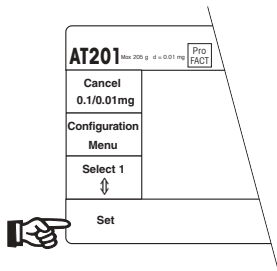

- When you have selected the appropriate setting, press the **«Set» key**. The chosen setting then immediately becomes active, and the balance returns to the weighing mode.

#### Note:

A further reason for an unstable display of the weighing result could lie, for instance, with electrostatic charging of the weighing sample or the container. You will find additional information regarding this in Section 7.1.

### 3.4 How to switch off the fully automatic door function

You are already familiar with the convenient automatic door function of your AT balance from your first weighing. When the automatic door operation is switched on, the draft shield closes automatically after the «Re-Zero» key (zeroing/taring) or the «Print» key (printout of the weighing result, see Section 5.6) has been pressed. As soon as the weight display is stable, the draft shield is reopened for the next weighing operation (e.g. weighing in, loading the balance). The draft shield is thus always in the correct position for the next weighing process. Routine

work is particularly facilitated by this automatic operation. It is also useful in the percent weighing (Section 5.2) and piece counting (Section 5.3) applications. When the twin foot switch (see brochure) is used, the automatic operation leaves **both** hands free for weighing in.

If you wish to operate the draft shield manually or semiautomatically via the two  $\updownarrow$  keys, however, you can **switch off the automatic door operation**:

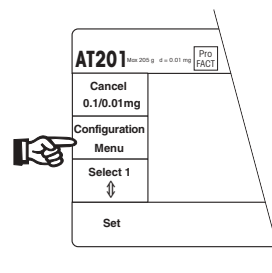

- Select the menu.

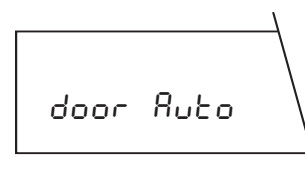

- Press the «**Menu**» key repeatedly until the adjacent display appears.

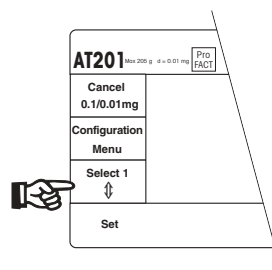

- Using the «**Select 1**» key, you can now switch the automatic door operation off and on again:

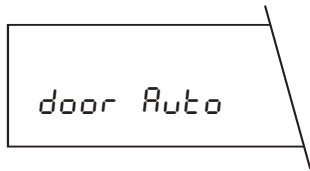

door Auto

Fully automatic door function  
switched on

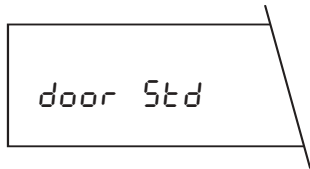

door Std

Fully automatic door function  
switched off

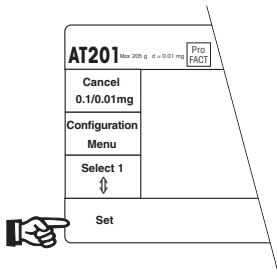

- Activate the chosen setting by pressing the «Set» key and you will be returned once again to the weighing mode.

## 4 Additional possibilities with your AT

In addition to the menu, the AT offers you further, very specific adaptation possibilities. You perform these adaptations in the **configuration register**, which we will introduce you to in the following section.

### 4.1 What is the configuration register?

The configuration register is divided into four sectors in which you can vary the following settings:

- Operational setting
  - Reset
- Basic settings
  - ASD, automatic stability detector
  - Readability
  - Readability in the semimicro range
  - Autozero
  - proFACT, adjustment and linearization

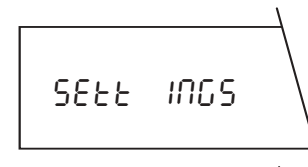

SEtE INGS



SCALE



Unit

- Weighing units
  - weighing unit 1
  - weighing unit 2
  - status indicator
  - beeper

Int -FACE

- Interface
  - data transmission mode
  - data transmission rate
  - parity
  - transmission protocol
  - end-of-line mode

You will find further details on the adjustment parameters on pages 82 and 83.

## 4.2 How is the configuration register used?

**Hold the short-form operating instructions in your hand. You will then have the complete configuration register at a glance in front of you.**

We would like to encourage you **to experiment** with the configuration register to familiarize yourself with it. **You need have no worries on this score: By pressing the «Cancel» key, you can return at any time to the weighing mode without any of the stored settings being altered!**

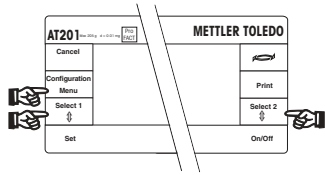

By pressing and holding the «**Configuration**» key, you call up the configuration register.

You select the different

- sectors («Configuration» key)
- parameters («Select 1» key)
- settings («Select 2» key)

by simply pressing the appropriate key. In contrast to the menu, you also need the «**Select 2**» key for operation of the configuration register.

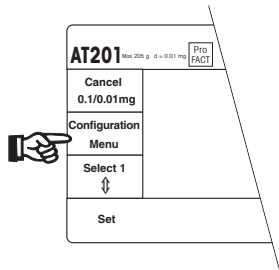

«Configuration» key

Selection of the **configuration register** from the weighing mode by **pressing and holding** the key (about 5 seconds). You are then already in the first sector.

Selection of the individual **sectors** in the configuration register with a brief keystroke. After the last sector you are returned to the first.

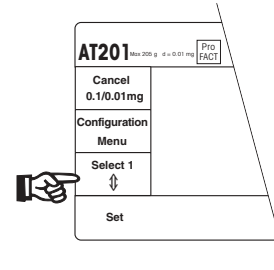

«Select 1» key

Selection of the **parameters** in a sector. After the last parameter in this sector you are returned to the first.

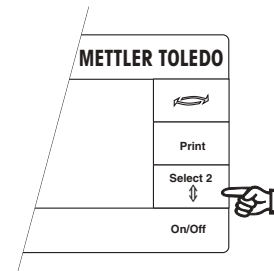

«Select 2» key

Selection of the desired **setting** of a parameter. After the last setting of a parameter, you are returned to the first.

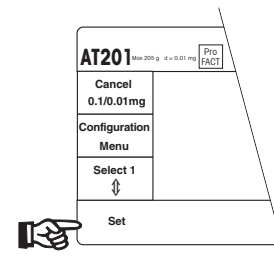

«Set» key

**Confirmation** of your selection and return to the weighing mode. The selected settings are stored and remain so even after the balance has been switched off or disconnected from the power supply.

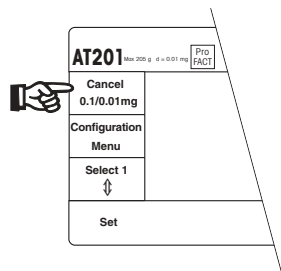

## «Cancel» key

**Exit** the configuration register and return to the weighing mode **without** any **changes** being stored. If you have made a wrong selection, you can quit the configuration register **at any time** by pressing the «Cancel» key. You are then again in the weighing mode **without any setting having been altered**. Instead of pressing the «Cancel» key, you can also switch the balance off, then immediately on again.

\*

2400 bd

Your AT balance is naturally not supplied with an empty configuration register. We have already included **standard settings** for you. You can recognize these **factory settings** by the **asterisk** in the upper left corner of the display.

## A further tip:

If you are in the configuration register and you do not press a key for about 1 minute, your AT automatically returns to the weighing mode. In this case, any alterations in the settings are ignored.

In the following sections you will learn what parameters you can select in what sectors, and what settings are available. You will find the **first example** in the **setting of the parameter “Automatic stability detection” (ASD)** in Section 4.4. In the following sections, you will also find recommendations for the correct setting of your AT balance. Further useful tips are contained in the enclosed booklet “Weighing the right way”.

### 4.3 In the first sector you return to the factory settings

As you have learned in the preceding section, the configuration register of your AT balance has been preset in the factory. Even if you have modified the settings, you can return to the factory setting at any time.

**But here all specific settings, even those in the menu, will be replaced by the factory settings!**

You undertake the return to the factory settings in the first sector (operational settings). This sector contains only a single parameter:

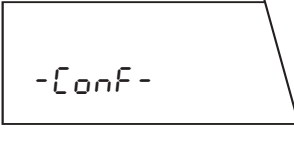

-CONF-

- Select the configuration register by pressing and holding the «**Configuration**» key. As soon as the display shown opposite appears, release the key.



SEttingS

- You are now in the first sector (*Settings*) of the configuration register.



rESEt

- Select the first (and only) parameter («**Select 1**» key).

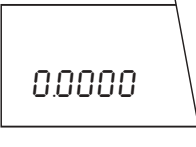

0.0000

- Activate the resetting by pressing the «**Set**» key, and the scale returns automatically to the weighing mode. You again work with the factory settings.

#### 4.4 The second sector offers you numerous adaptation possibilities



- Select the configuration register by pressing and holding the «Configuration» key. Then select the second **sector** (basic settings) by pressing the «**Configuration**» key briefly.

In this sector you can select the following **parameters** and their settings:

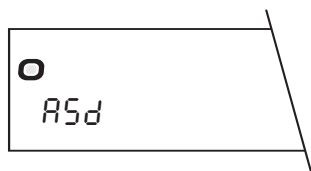

##### Automatic stability detection (ASD)

Your AT possesses an automatic stability detection. As long as the balance is **unstable**, the stability detection symbol remains lit up in the upper left corner of the display. The symbol fades and the weighing result is released only when the result is within

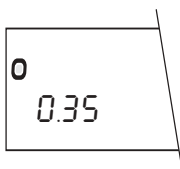

the limits selected by you for the stability.

You have a choice of eight settings. In the setting *ASd-1*– the display must be within a preset tolerance limit for **one second** for the result to be released as stable. In the setting *ASd-7*– the result must be within a preset tolerance limit **for several seconds** before being released.

- Select the first parameter, the automatic stability detection (*ASD*), with the «**Select 1**» key.
- Select the appropriate setting with the «**Select 2**» key. The following illustration shows the relationship between the repeatability and the weighing speed.

Stage	Weighing speed	Repeatability
off		
1	very fast	good
2		
3 *		
4		
5		
6		
7	fast	very good

In the *oFF* position, the balance does not wait for attainment of stability; each result is considered stable. This setting is used in special applications in connection with the serial data interface (see also Section 4.6 “Data transmission mode”).

\* = factory setting

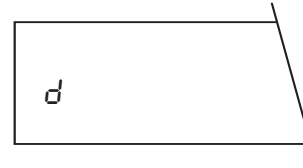

### Readability (selection of the readout increments)

In this parameter you define the readout increments (digits) for the last decimal place. Readout increments of 1, 2, 5 and 10 are available, and these are symbolized by the following setting options:

AT20	AT201 / AT261 DeltaRange® / AT200 / AT400	AT460 DeltaRange®
0.01 mg*	0.1 mg*	1 mg*
0.02 mg	0.2 mg	2 mg
0.05 mg	0.5 mg	5 mg
0.1 mg	1 mg	10 mg

\* = factory settings

Select readout increments as large as your application allows; the larger the readout increments, the faster the operation of your balance.

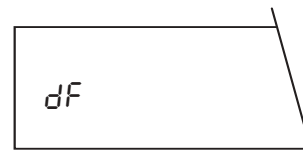

### Readability (Selection of the readout increments) in the fine range

This parameter is available only with semimicro and DeltaRange® balances!

Here you define the readout increments (digits) for the last decimal place in weighings in the fine range. Readout increments of 1, 2, 5 and 10 are available, and symbolized by the following setting options:

AT20	AT201 / AT261 DeltaRange®	AT460 DeltaRange®
2 µg*	0.01 mg*	0.1 mg*
5 µg	0.02 mg	0.2 mg
10 µg	0.05 mg	0.5 mg
0.1 mg	0.1 mg	1 mg

\* = factory settings

Select readout increments as large as your application allows; the larger the readout increment, the faster the operation of the balance.

With the «0.1/0.01 mg» key you toggle between the coarse and fine range of DeltaRange® balances. Switching is possible only below a limit which depends on the model (see also Section 2.4).

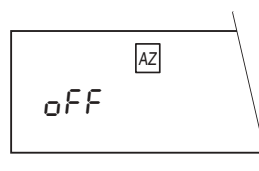

## Autozero (AZ)

In this parameter you switch the automatic zeroing (autozero) on or off. When switched on, the zero is automatically corrected for drift or contamination of the weighing pan.

- Autozero on \*

- Autozero off

\* = factory setting

For particular applications (e.g. evaporation measurements), it can be an advantage to switch the autozero function off.

CALIN

## Adjustment and linearization with proFACT

In this parameter you define the adjustment mode i.e., the way in which your balance should be adjusted and linearized. The following possibilities are available:

\* CALIN  
Auto on

- The AT balance adjusts and linearize itself **fully automatically** by loading two internal adjustment weights. The process is initiated as soon as a change in the operating conditions makes this necessary. One of the most important initiation criteria is a temperature fluctuation in the surroundings of  $\pm 1.5\text{ }^{\circ}\text{C}$ . You do not have to concern yourself with the adjustment of the balance. The adjustment and the simultaneous linearization provide you with the surety that the displayed value matches the mass of the loaded weight over the entire weighing range of your AT.

## proFACT professional fully automatic adjustment and linearization technology

### 1. Adjustment

The two internal adjustment weights are loaded. The display is adjusted so that the loaded weight matches the display-ed value. (Correction of the slope of the straight line).

### 2. Linearity

The internal weight  $m_1$  is loaded alone and together with the weight  $m_2$ . The linearity is adjusted using the different display values for  $m_1$  in both measurements. If the two displayed values,  $y_1$  and  $y_2$ , are equal, the linearity is adjusted. (Correction of the deviation from the shape of an ideal straight line).

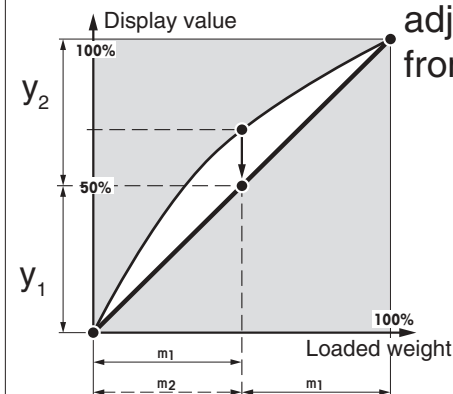



In this mode you can also initiate the fully automatic adjustment and linearization at any time with a keystroke. This is practical, for instance, when your AT reports during a weighing that it wishes to adjust itself. Section 5.4 shows you how to proceed in such a case.

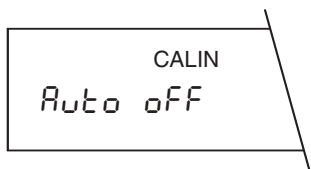

- The fully automatic **self-adjustment with linearization adjustment (proFACT)** described above is **switched off**. You can trigger the adjustment with the internal adjustment weights **at a keystroke**. After initiation, the adjustment runs automatically, and at the same time the measuring range is linearized. Section 5.4 shows you how to proceed in this case.

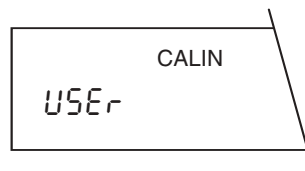

- You use your **own, external adjustment weight** for the adjustment. The procedure is described in Section 5.4 of these operating instructions. proFACT is not active in this setting.

\* = factory setting

## 4.5 In the third sector you select the weight units and additional settings

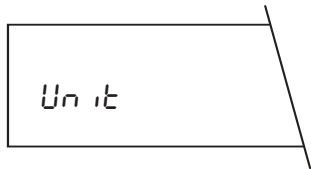

Select the third sector (weight units) in the configuration register.

In this sector you can select the following parameters and their settings:

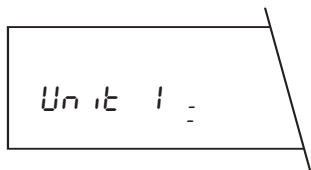

### Weight unit 1

The following weight units are available:

#### Display Name

g*	gram
mg	milligram
oz	ounce
ozt	Troy ounce
tl	tael (see note)
GN	grain

dwt	pennyweight
ct	carat, metric
C.M.	carat, metric (GB)
mo	momme

\* = factory setting

The number of decimal places in each unit is dependent of the balance model.

By pressing the  key, you toggle between weight unit 1 (*Unit 1*) and weight unit 2 (*Unit 2*). Section 5.1 provides you with further details regarding this switching. A conversion table for the weight units is given in Section 7.6.

#### Note for weight unit **tael**:

You have the possibility to choose between three national tael units:

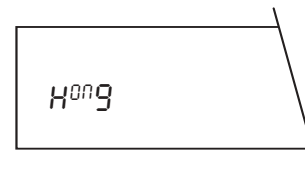

If you have selected the tael unit with the «Select 2» key, press the «Select 1» key until the adjacent display appears.

With the «Select 2» key you can now select the desired national tael unit:

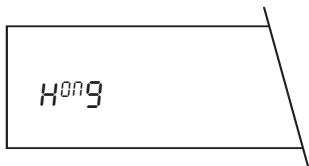

**Hong Kong** (factory setting)



**Singapore, Malaysia**



**Taiwan (Republic of China)**

Confirm your selection by pressing the «Set» key.

You need perform the selection of the national tael unit you require only **once**. After this, whenever you configure tael as a weight unit, the national tael unit you have preselected will be used.

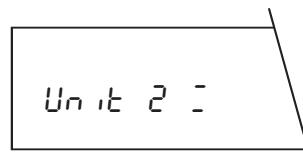

## Weight unit 2

You have available the same weight units as with weight unit 1 and also the **application units piece and percent**:

Display	Name
g	gram
mg*	milligram
oz	ounce
ozt	Troy ounce
tl	tael (see note Tael under weight unit 1)
GN	grain
dwt	pennyweight
ct	carat, metric
C.M.	carat, metric (GB)
mo	momme
PCS	pieces
Stk	pieces (German)
%	percent

\* = factory setting

The number of decimal places in each unit depends on the balance model.

By pressing the key , you toggle between weight unit 1 (*Unit 1*) and weight unit 2 (*Unit 2*). You will find further details in Section 5.1. A conversion table for the weight units is given in Section 7.6.

The application units «piece» and «percent» are described in detail in Sections 5.2 and 5.3.

### Graphic indicators

The graphic indicators **26**, such as the symbols for the vibration adapter and the weighing process adapter, provide you with an overview of the selected settings. These graphic indicators can be switched on or off.

- A few minutes after the balance has been switched on, the symbols fade\*.

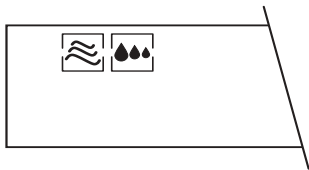

- The symbols are displayed permanently.

\* = factory setting

### Beeper setting

The audio acknowledgement beep supports the operation of the balance and the display audibly. You can switch it off or on.



- audio acknowledgement beep switched on \*



- audio acknowledgement beep switched off



\* = factory setting

## 4.6 In the fourth sector the AT reveals itself as a balance ready to communicate

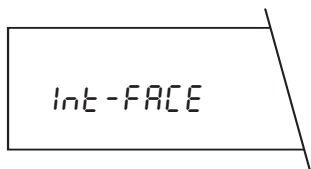

- Select the fourth sector in the configuration register (interface).

For the attachment of a non-METTLER TOLEDO printer or a PC you can select the parameters for the data transmission via the serial data interface and their settings in this sector. You will find more detailed information regarding use of the interface in the instructions “**Bidirectional Interface of the METTLER TOLEDO AT balances**”, which is available from METTLER-TOLEDO.

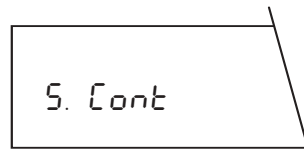
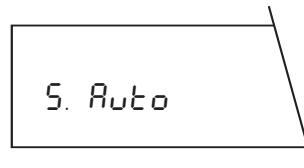
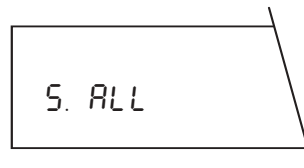
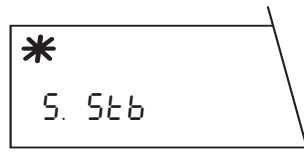
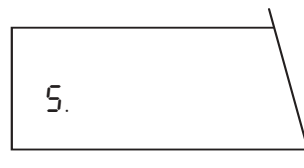

## Data transmission mode

The following setting options are available:

- **Send stable:** The **first stable value** is transferred after initiation of the print command after release by the automatic stability detection. \*
- **Send all:** The **current value** is transmitted after initiation of the print command.
- **Send automatically:** The **first stable value** is transmitted automatically **after every weight increase of at least 0.01 g.**
- **Send continuously:** **All prepared values** are transmitted continuously.

\* = factory setting

**Important note:**

If you have switched off the automatic stability detection in sector 2 (*ASD OFF*), all weight values are regarded as being stable. After the «Print» key has been pressed in this case, the following values are transmitted:

In setting *S.Stb*: The current value as in the setting *S.ALL*.

In setting *S.Auto*: The first value after a weight change of more than 0.01 g.

bd

\*  
2400 bd

**Data transmission rate (baud rate)**

The data transmission rate (baud rate) determines the speed of the transmission via the serial interface. The unit is the baud (1 baud (bd) = 1 bit/second). The following transmission rates are available:

- 150 db
- 300 db
- 600 bd
- 1200 bd
- 2400 bd \*
- 4800 bd
- 9600 bd

\* = factory setting

**Parity**

With the aid of the parity test, simple bit errors in the data transmission can be recognized by a parity check. The following setting options are available:

PAR

\*  
PAR -E-

PAR -O-

- **Parity Even \***
- **Parity Odd**

PAR OFF

- **Parity Off**

PAR SPc

- **Parity Space**

\* = factory setting

### Transmission protocol (HandShake)

HS

These settings allow matching of the data transmission to various serial receivers. The following settings are available:

\* HS PAUSE

Pause of 1 second (for METTLER-TOLEDO GA42 Printer) \*

HS CL

- METTLER TOLEDO transmission protocol. In this operating mode, the end-of-line mode is automatically set to "crLF" and can not be changed.

HS OFF

- No handshake

HS HARD

- Hardware handshake (DTR/CTS)

HS SOFT

- Software handshake (XON/XOFF)

\* = factory setting

### End-of-line mode

Two setting options are available:

EOL

- Balance return and line feed at end of line\*

\* EOL crLF

- Balance return at end of line

EOL cr

\* = factory setting

**Important note:**

If *HS CL* is set in the transmission protocol, the end-of-line mode is set automatically to *EOL crLF* and can not be changed.

## 4.7 Print out the current configuration

You can print out the configuration currently stored on an attached printer. This record is useful if you work with different configurations. You then know at all times which values should be set for which application.

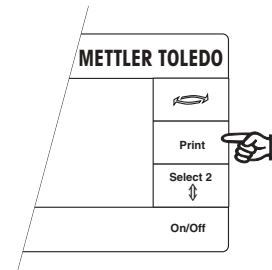

Proceed as follows for the printout:

- Select the configuration register.
- Press the «Print» key, and the current configuration will be printed out.

**A further tip: Always print out your specific configuration. You thus have a record of your settings and even if you return to the factory settings, you can restore your configuration at any time.**

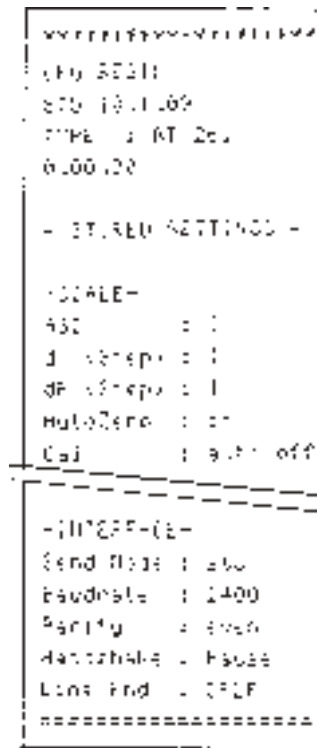



## 4.8 How to protect your settings against inadvertent change

As you know, with one press of the «Set» key your individual settings in the configuration register are stored. These are available at any time (even if the balance has since been disconnected from the power supply). You are not, however, protected against inadvertent alterations, for instance by other balance users.

To safeguard the settings, proceed as follows:

- Disconnect the cable of the AC adapter from the receptacle.
- Remove the cover of the plug-in slot **21** at the rear of your AT balance.

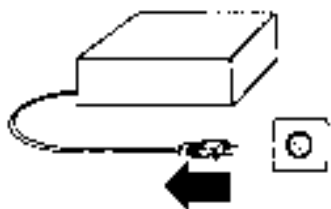

- Grasp the bracket of the program cassette **22** and withdraw this carefully from the plug-in slot **21**.

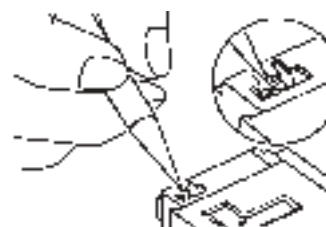

- Remove the jumper with a thin pin or a needle from the contact pins.

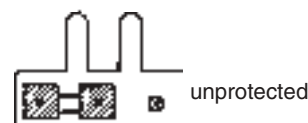

- If you wish to protect your individual settings in the configuration register against inadvertent changes, place the jumper across both contact pins.



- Slide the program cassette **22** into the plug-in slot **21** up to the stop and replace the cover. Plug the cable of the AC adapter into the receptacle.

**If you have secured your settings, the configuration register is no longer accessible and no more alterations can be made.**

- To remove the safeguard, proceed in the reverse sequence.

## **5 Special applications and functions of your AT balance**

Your AT balance is also prepared in the best possible way for special cases. Applications and functions built in as standard expand the possibilities of your AT balance and facilitate the operation. The following section familiarizes you with these applications and functions.

### **5.1 Your AT can work with two weight units**

With your AT balance you can toggle between two preselected weight units at any time. Section 4.5 of these operating instructions shows you how to select and store these two weight units in the configuration register.

You have, for example, selected “mg” as weight unit 1 and “ct” as weight unit 2 in the configuration register. You can switch between these two units at a keystroke:

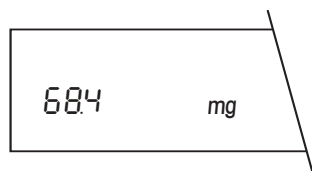

The balance is now operating with weight unit 1.

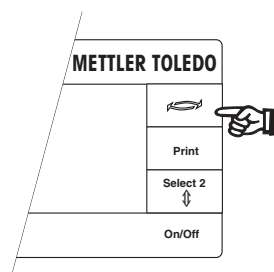

- Press key  briefly and...

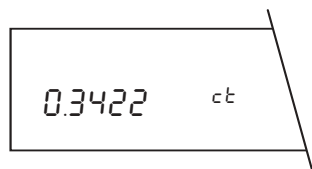

- ...the balance now works with weight unit 2. By pressing the  key again, you can return to weight unit 1.

The table in section 7.6 shows you the conversion factors between the various weight units.

## 5.2 Your AT also weighs in percent and shows plus/minus deviations

This built-in application allows you to weigh in to a **preset value** (100%) and to determine **deviations from this target value**.

So that this application appears in the menu, you must set the unit to percent (%) under the parameter “Weight unit 2” (*Unit 2*) in the “Weight units” (*Unit*) sector of the configuration register as described in Section 4.5.

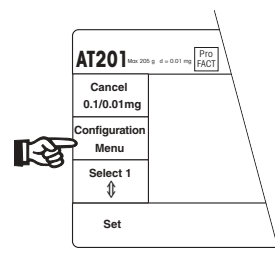

- Press the «Menu» key briefly and the AT requests you to load the **reference weight**.



**Note:** This request appears only if weight unit 2 is set to percent (%).

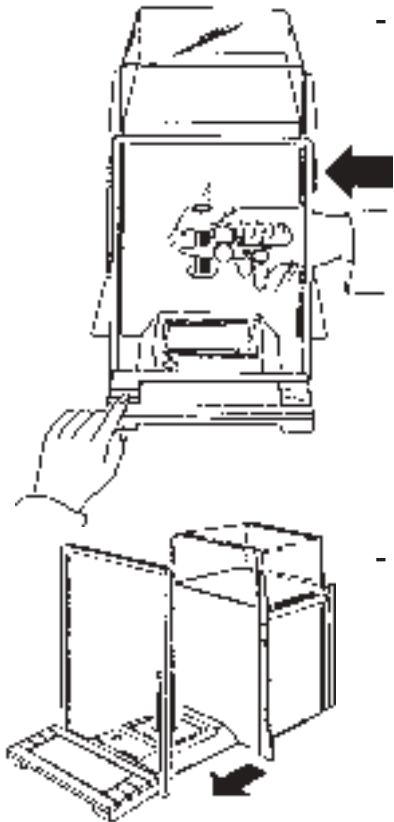

- Open the draft shield and load the reference weight.

- Press the «Set» key and the draft shield closes automatically if the automatic door function is switched on. If not, close the draft shield manually or by pressing one of the two keys  $\updownarrow$  and then press key «Set».

As long as the horizontal dashes are displayed, your AT is weighing the reference weight.

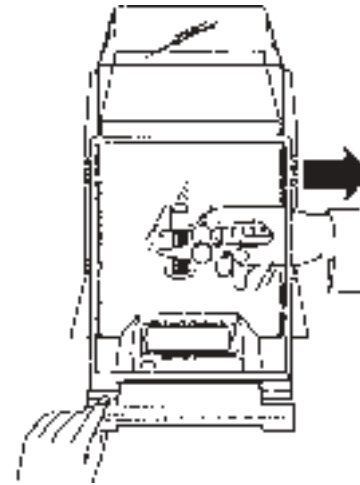
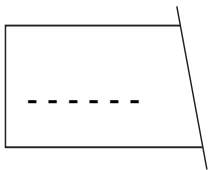

- As soon as the horizontal dashes disappear, the reference weight has been read in and your AT is ready for weighing. If the automatic door function is switched on, the draft shield opens automatically after completion of the weighing process. If not, open it yourself. Remove the reference weight.

-2.5% 100% +2.5%



The DeltaTrac® now shows a plus and a minus marking that displays the tolerances of plus and minus 2.5%.

#### Now **first weigh in coarsely:**

- Place the empty container on the pan and set the balance to zero (taring).

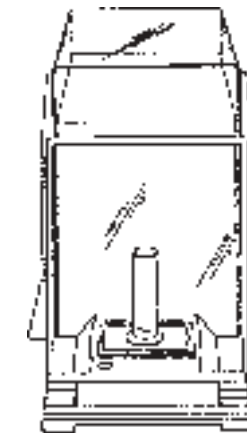

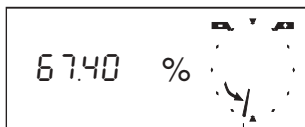

coarse indicator

- Add the weighing sample at a steady rate to the container until the coarse indicator on the DeltaTrac® is pointing **vertically downward**. This shows that the approximate target weight has now been reached.

fine indicator

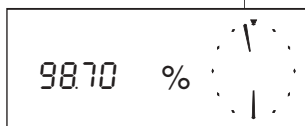

Now perform the **fine weighing**:

- After the coarse weighing in, you now add the weighing sample carefully until the fine indicator on the DeltaTrac® is pointing **vertically upward**.



- When the fine and the coarse pointers form a **vertical line**, the set weight is within **± 0.25%** of the target.

If you possess a dual-range balance (semimicro balance), you also have a fine range available in the weight unit %, in which additional decimal places are displayed.

With the **key**  you can display **either the percentage or the weight** (see also Section 5.1).

### 5.3 Should your AT count pieces?

First your AT needs to know that you wish to perform piece counting. You make this setting in the third sector of the configuration register (*Unit*), where you set weight unit 2 (*Unit 2*) to *PCS*. This setting is described in Section 4.5.

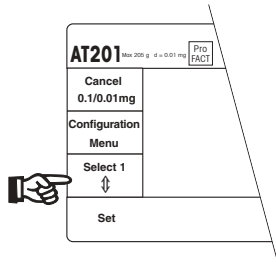

- Open the draft shield manually or by pressing one of the two keys  $\updownarrow$ .

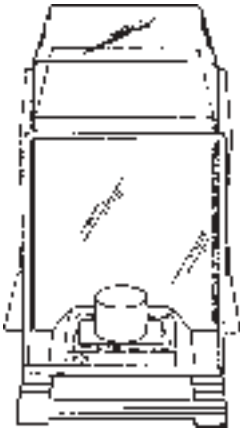

- If you wish to **count into** a container, load the **empty** container.

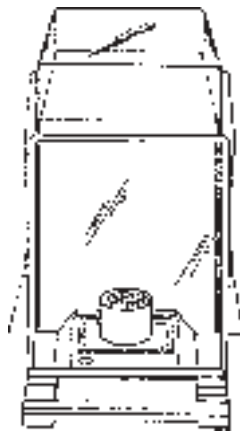

- If you wish to **count out** of a container, load the **full** container.

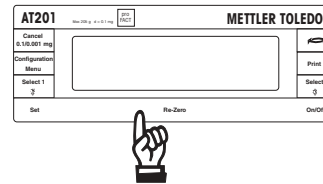

- Set the scale to zero (taring).

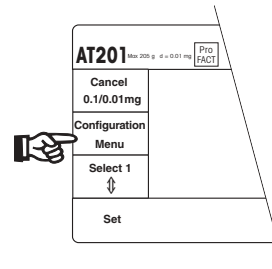

- Your AT now needs the weight of a **reference piece number**. Press the «Menu» key briefly.

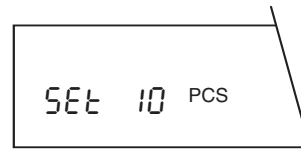

### Note:

This menu selection appears only when weight unit 2 is set to piece .

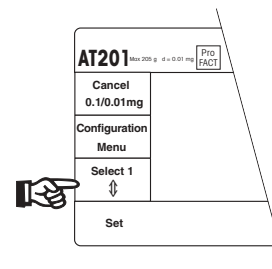

- Select the desired **reference piece number** with the «Select 1» key. The following piece numbers are available:

10      20      50      100

**Note:** We advise you to select a reference piece number as large as possible since your AT determines the average weight per piece. Since it is seldom the case that all pieces are equally heavy, the reference weight that is stored is naturally more accurate the greater the reference piece number.

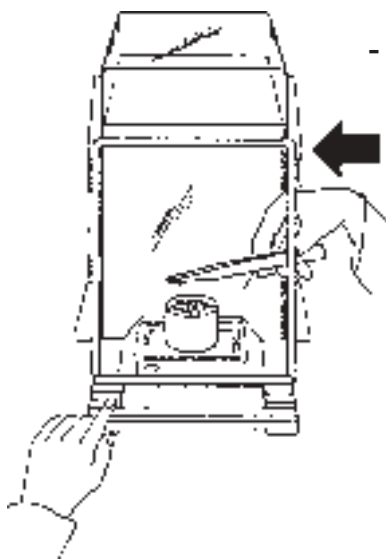
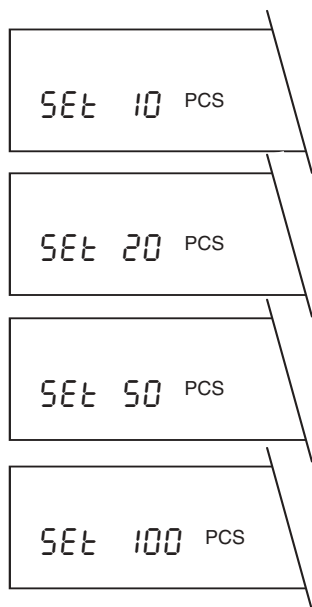

- If you wish to **count into** a container, **add** the selected number of pieces (reference piece number) of the weighing sample to the container.

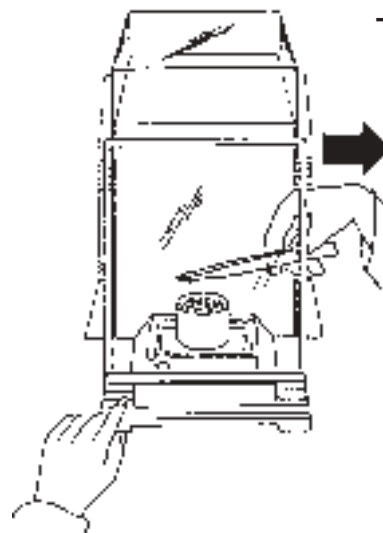

- If you wish to **count out** of a container, **remove** the selected number of pieces from the container.

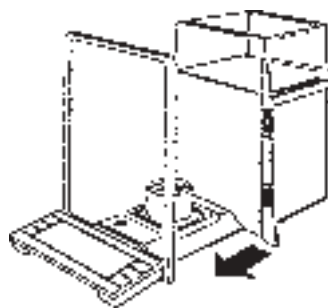

- Press the «Set» key, and the draft shield closes automatically if the automatic door function is switched on. If not, close the draft shield manually or by pressing the **right-hand** key  $\updownarrow$  and then press the «Set» key.

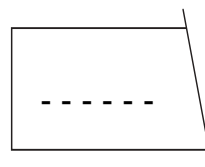

As long as the horizontal dashes are displayed, your AT is weighing the reference weight.

- As soon as the horizontal dashes disappear, the reference piece number and the reference weight have been read in and your AT is ready for counting or weighing.

If the automatic door function is switched on, the draft shield opens automatically on completion of the weighing-in process. If not, open it yourself.

Depending on how you have weighed in the reference weight, you can now:

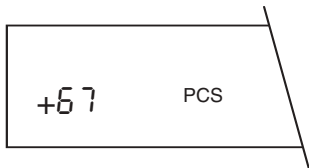

- **Count into** the container with display of the total number of pieces in the container or...

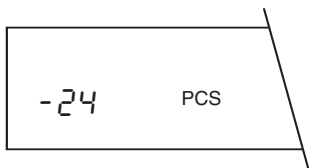

- ...**count out** of the container with display of the number of pieces removed from the container.

With the key  you can **display either the piece count or the weight** (see also Section 5.1).

## 5.4 How to trigger the adjustment manually

In the factory the balance is preset to proFACT. The AT balance adjusts and linearizes itself as soon as a change in the ambient conditions makes this necessary. You thus need not concern yourself with the adjustment. But you also have the possibility to trigger the motorized adjustment with the internal adjustment weights at all times at a keystroke. This can be practical if the audio warning beep sounds during a weighing and the adjacent symbol appears in the display. This is your AT's way of showing you that it would like to adjust itself. You can now either interrupt your work at the next convenient opportunity for about 5 minutes, when the AT will adjust itself, or, you yourself can trigger the motorized adjustment by pressing a key.

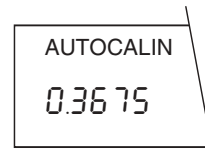



You select the adjustment mode in sector 2 (*SCALE*) of the configuration register (see Section 4.4). In addition to the **fully automatic self-adjustment**, you have two further adjustment possibilities available:

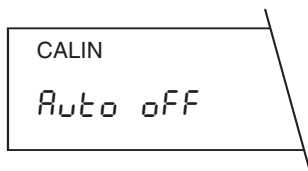

CALIN  
Auto off

- You trigger the **automatic adjustment with the internal adjustment weights**, with simultaneous automatic linearization of the measuring range at a keystroke.

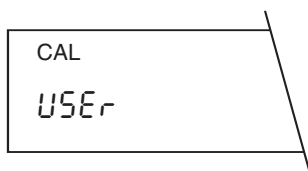

CAL  
USER

- The **manual adjustment with an external adjustment weight**, without linearization of the measuring range.

If you have switched off the automatic self-adjustment, you should adjust the balance occasionally.

### **Automatic adjustment with the internal adjustment weights at a keystroke**

You have this adjustment mode available if you have set the parameter “adjustment and linearization” in sector 2 of the configuration register (basic settings) either to *CALIN Auto on* or *CALIN Auto off*.

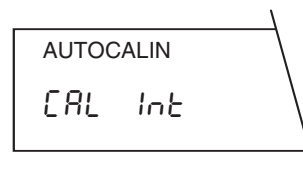

AUTOCALIN  
CAL Int

- Repeatedly press the «Menu» key briefly until the adjacent display appears.

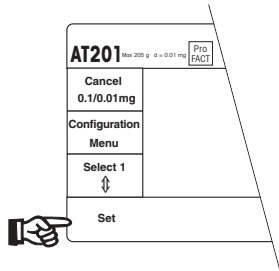

- Trigger the adjustment procedure by pressing the «Set» key. The draft shield now closes automatically if the automatic door function is switched on. If not, close the draft shield manually or by pressing one of the two  $\updownarrow$  keys.
- You can follow the adjustment and linearization procedure in the numerical display and on the DeltaTrac®, and you also hear when the internal weights are loaded.

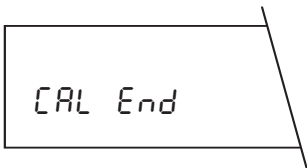

Completion of the adjustment and linearization process is displayed briefly,...

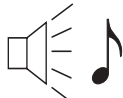
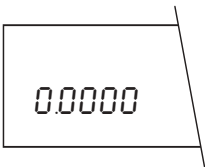

...the audio warning beep sounds and the balance returns to the weighing mode.

## Manual adjustment with external adjustment weight

You wish to use your own external adjustment weight for the adjustment and have set the parameter proFACT (adjustment and linearization) to «CAL USEr» in sector 2 of the configuration register (basic settings). In this mode the **automatic adjustment and linearization with the built-in adjustment weights is switched off.**



- Repeatedly press the «Menu» key briefly until the adjacent display appears.
- Trigger the adjustment procedure by pressing the «Set» key. The draft shield now closes automatically if the automatic door function is switched in. If not, close the draft shield manually or by pressing one of the two  $\updownarrow$  keys.

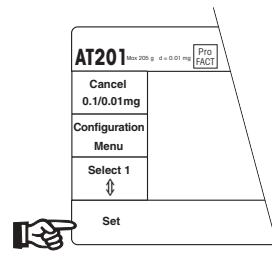

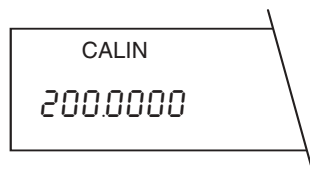

After a short time, the audio warning beep sounds and the requested, model-dependent adjustment weight appears in the display, for example, 200 g.



- Open the draft shield, load the requested adjustment weight and close the draft shield.

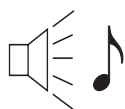

- Wait until the audio warning beep sounds. The display now requests the removal of the adjustment weight.



- Open the draft shield, remove the adjustment weight and close the draft shield.

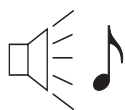
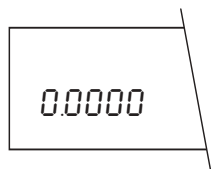

As soon as the audio warning beep sounds and the adjacent display appears, the adjustment is finished and your AT is again in the weighing mode.

## 5.5 How to check whether the balance is still adjusted correctly

In the factory, the balance is set to proFACT, professional fully automatic adjustment and linearization technology. A check of the adjustment is not necessary in this mode. If you have selected the automatic adjustment mode with manual triggering (*CALIN Auto OFF*) in sector 2 of the configuration register (see Section 4.4), it is advisable to check the adjustment with the internal adjustment weights occasionally.

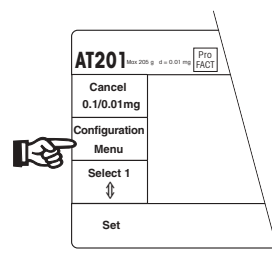

- Select the menu by pressing briefly the «Menu» key.

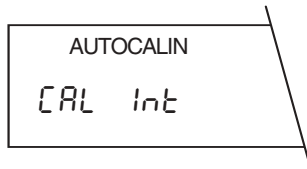

AUTOCALIN  
CAL Int

- Repeatedly press the «Menu» key briefly until the adjacent display appears.

**Note:**

This display does not appear if you have set the parameter “adjustment and linearization” to *CAL USEr* in the configuration register (adjustment with your own external adjustment weight). Please also see the note at the end of this section.

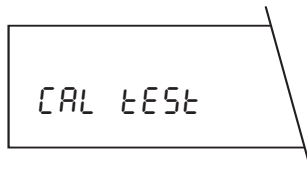

CAL tEST

- Select the adjustment test by pressing the «Select 1» key.
- Start the test by pressing the «Set» key. If the fully automatic door function is switched on, the draft shield now closes automatically. If not, you first close the draft shield manually or by pressing one of the two  $\updownarrow$  keys and then the «Set» key.

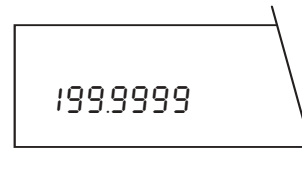

199.9999

The internal weights are now loaded, without the balance being adjusted, and the current, model-dependent adjustment value displayed, interrupted by the display *tEST*.

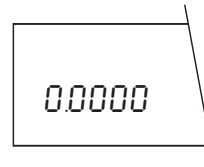

0.0000

- When you have read off the value, abort the test by pressing the «Set» or «Cancel» key. The balance is then again in the weighing mode.

**Notes:**

If the deviation of the adjustment weight is more than  $\pm 0.00015\%$  (1.5 ppm) from the full load, the balance should be adjusted (see Section 5.4).

If you work with your own, external adjustment weight (parameter “adjustment and linearization” set to *CAL USEr* in the configuration register), you can check the adjustment of the balance by loading your own, external adjustment weights.

## 5.6 How to print out the weighing result

You can output the weighing result via the interface connection **19** on a printer. If you wish to attach a non-METTLER TOLEDO printer, you match the parameters of the data interface to the specifications in the printer handbook (see Section 4.6). You will find further details in the instructions “Bidirectional interface of the METTLER TOLEDO AT balances”, which you can order from METTLER TOLEDO.

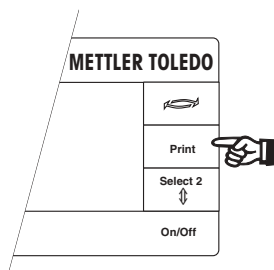

- In the weighing mode press the «**Print**» key briefly.

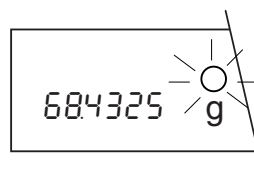
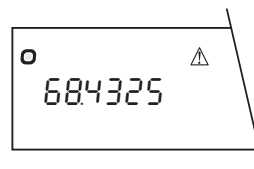

- As soon as the result is stable, it is transferred via the interface connection **19** to the printer. Up to the transmission, the triangle symbol is lit up in the display. If the transmission has not yet taken place, you can abort the procedure by pressing the «Print» key again briefly. After the transmission, the result is kept for about 5 seconds in the display for checking purposes, and a ring symbol flashes at the upper right.
- **Notes:**  
The type of transmission depends on the selected data transmission mode, which you have set in the fourth sector of the configuration register (see Section 4.6). If you have selected the *S.Stb* or *S.Auto* mode and the automatic door function is switched on, the draft shield is closed, the result transmitted and then the draft shield opened again. If not, you close the draft shield manually or by pressing one

of the two ⇅ keys.

- The transmission command can also be triggered with the hand or foot switch (available as an accessory).

## 5.7 Your AT can also be remote controlled

The **complete operation** (keypad and draft shield) as well as the menu and the configuration register of your AT balance can also be controlled **via a computer**. This allows you to incorporate your AT in an automation system and, for instance, is also suitable for loading by a **robot**.

The draft shield, the zeroing (taring) of the balance and the print command can also be controlled externally via an **electrical contact** (relay, proximity switch). The connections for the electrical contacts **18** are at the rear of your AT balance.

Further information regarding the connection of an external robot or an electrical contact can be found in the operating instructions "**Bidirectional data interface of the AT balances**".

## 6 Important information regarding your AT balance

### 6.1 The AC adapter offers you various installation options

You can naturally place the AC adapter supplied anywhere in the vicinity of the balance within the radius of the connection cable. But in addition, the AC adapter also offers you two advantageous and space-saving installation possibilities.

#### Direct attachment to the balance

You can attach the AC adapter directly to your AT balance.



#### Note:

Owing to the heat developed by the AC adapter, this type of installation **is not advisable with semimicro balances** (resolution 0.01 mg).

- Remove the two fastener screws at the rear of your AT balance.
  
- Attach the AC adapter holder supplied to the rear of the balance with the two screws. The arrow on the holder must be visible and point upwards.

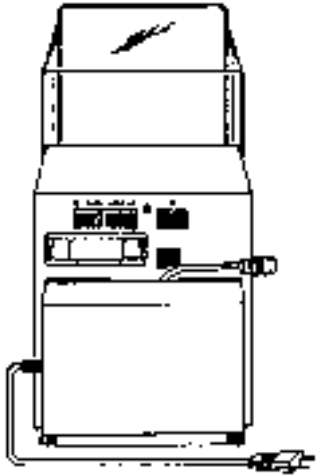

- Position the four feet in the slots of the AC adapter. Hold the connection cable to the **right** and it slides into the central slot of the holder automatically.

**Note:**

You can attach the AC adapter such that the power cable exits at the **right**.

- Press the AC adapter gently downward the stop.

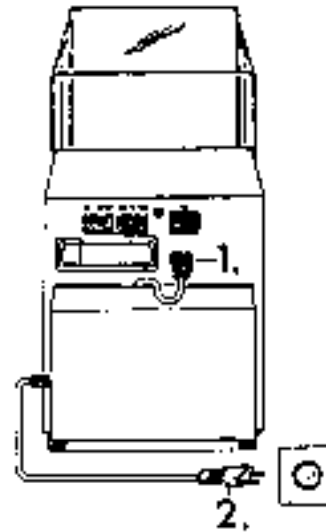

- Connect the AC adapter **first** to connection socket **23** of the balance and **then** to the power supply.

**Wall mounting**

- If you wish to save space at the workplace, you can mount the AC adapter on the wall:
- Decide on a suitable place for the AC adapter. Take the length of the connection cable into account.
- Use the AC adapter holder as a template to mark out the drill holes.

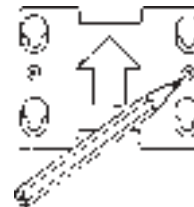



- Drill the holes and use the dowels in the installation set supplied should the wall material require it. Fix the AC adapter holder such that the arrow is visible and pointing upward.

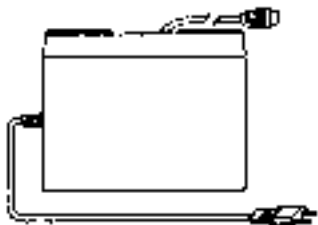

- Hold the unit so that the connection cable exits from the **top** and position the four feet in the slots in the holder. Hold the connection cable to the **right** while doing so and it will slide into the central slot of the holder automatically.

**Note:**

You can also fix the AC adapter so that the connection cable exits from **below**. In this case hold the connection cable to the **left** when engaging the AC adapter.

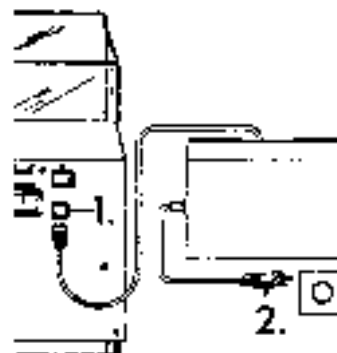
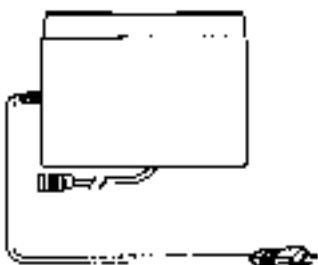

- Press the AC adapter gently downward to the stop.
- Connect the AC adapter **first** to connection socket **23** and **then** with the power supply.

## 6.2 If you change the location of your AT

If you wish to relocate your AT, please note the following:

- To transport your balance, grasp it at the front beneath the display and at the back under the balance housing. Never lift up your AT by the draft shield or by using the «Re-Zero» key!

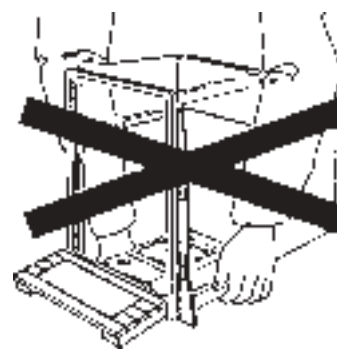
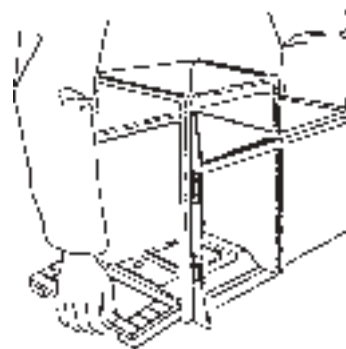

### 6.3 A well maintained balance is a joy forever

- Clean the weighing pan, the draft shield and the housing of your AT occasionally with the brush supplied.

If, for example, you wish to clean the base inside the draft shield at the left, **start with the brush from the right or from the top through the weighing chamber and at the same time open the left door with the left hand.** Residues that have accumulated on the base can easily be brushed out.

With the **AT20** you open the draft shield by pressing either the left or right  $\updownarrow$  key.

- For a thorough cleaning, lift off the weighing pan **15** and the draft cover **16** vertically upward. After cleaning, replace the weighing pan and the draft cover. When replacing the weighing pan, ensure that it has free movement in its slot and does not

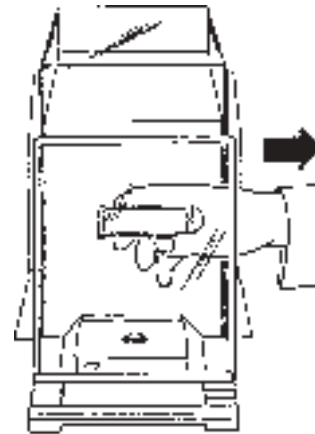
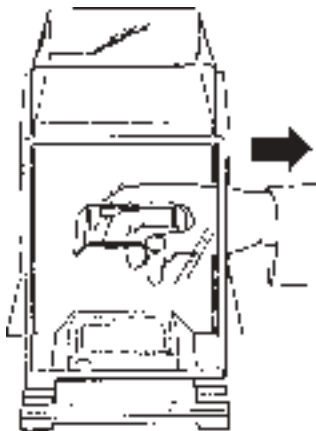
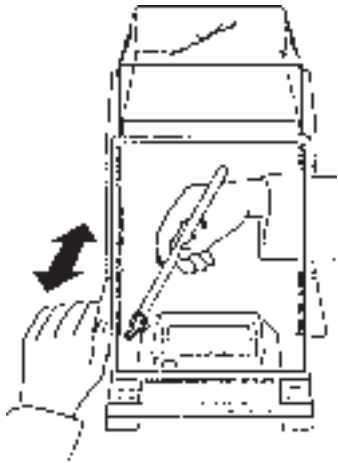

touch the draft cover. If necessary, turn the weighing pan to the correct position.



#### Cleaning

The balance housing and the weighing pan are made of high-grade, resistant materials. You can thus use any commercially available cleaning agent for cleaning.

- AT balances can best be cleaned with a damp cloth.



#### Cautionary note

Ensure that no liquid can enter the AC adapter or the balance.

## 6.4 What your AT brings with it

The following accessories are supplied with your AT:

- AC adapter with holder and installation set
- Operating instructions
- Short-form operating instructions
- "Weighing the right way"
- Cleaning brush
- METTLER TOLEDO weighing tweezers (for semimicro balances only)

## 6.5 Additional information and accessories for your AT balance

For **below-the-balance weighings** your AT is equipped with an opening for a hanger. Open the draft shield and place the balance on its back. Swing the cover of the opening on the underside of the balance aside. You can now attach a pan or a holder to the hook in the opening.

For the expansion of your AT balance, for special applications and for different types of weighing problems a variety of **peripheral units** and **information brochures** are available from METTLER TOLEDO.

## 7 Any questions?

### 7.1 What happens if the weight display is unstable?

Since it is not always easy to determine the exact cause of an unstable display the most frequent sources of error are listed below.

You will find detailed explanations in the enclosed booklet "Weighing the right way".

#### **An unsuitable location**

Strong drafts (e.g. from air conditioning systems) or vibrations of the bench are factors that can cause disturbances.

- Look for a suitable location, adapt the vibration adapter to the local conditions (see Section 3.3) and close the draft shield as fully as possible (see Section 2.1).

#### **An insufficiently closed draft shield**

- Close the draft shield as fully as possible (see Section 2.1).

#### **Electrostatic charging of weighing samples and containers**

This charging frequently appears in heated rooms with **dry air** (below 40-45% rel. humidity) and with weighing samples made of **glass** or **plastic**. The electrical charges generate forces that can disturb the weighing.

- In the simplest case, it may be sufficient to remove the draft cover **16** and place the weighing sample in a metal container.

### **Magnetic weighing samples or containers**

- In simple cases, it may be sufficient to increase the distance between the weighing sample and the weighing pan. For this, place the weighing sample **on** a nonmagnetic metallic (e.g. aluminum) or glass vessel. A further improvement can be achieved by removing the draft cover **16**.

### **Weighing samples or containers that are not at ambient temperature**

Weighing samples or containers that are warmer or colder than the ambient temperature of the balance can cause disturbing air currents and buoyancy errors. Weight changes due to the uptake or evolution of surface moisture can also be the cause. These lead to wrong or unstable weighing results.

- Wait until the weighing sample and the container have attained the ambient temperature. Do not touch the weighing sample or the container with your hand (about 35 °C), but use only the tongs or the tweezers.

### **Weighing samples or containers that absorb or evolve moisture readily**

All weighing samples or containers made of **wood, cardboard, paper, cork** (e.g. holder for round-bottomed flasks), **plastic** or **rubber** can absorb or evolve enough moisture to make the display unstable and cause display of nonreproducible or wrong weighing results.

- If at all possible, containers made of such material should be replaced by metal or glass vessels. If this is not possible, operations should at least be performed in a room with a constant atmospheric humidity.

### **The weighing sample or the container touches the draft cover**

- In such a case remove draft cover **16**.

### **The weighing pan is placed at an angle and touches the draft cover or the base**

- Turn the pan to the center position (see Section 6.3).

### **Contamination**

Powder, liquid or other residues at the edge of the weighing pan or between the weighing pan and the draft cover can lead to unstable displays if the weighing pan no longer has completely unrestricted movement.

- Clean the weighing pan and the draft cover (see Section 6.3).

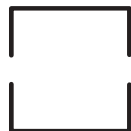

### The weighing process adapter is switched off

If the weighing process adapter is switched off, the weight display does not always achieve stability when the local conditions are unfavorable and measurements are performed in the semimicro range.

- Use this setting of the weighing process adapter exclusively for applications in which the **dynamics** of the weighing process are of prime interest (see Section 3.2).

## 7.2 How can the weighing speed be increased?

The weighing speed or the stabilization time of your AT is influenced considerably by the following factors and settings:



### Vibration adapter

If the local conditions allow (see Section 3.3), you can shorten the stabilization time of your AT by setting the medium or small wave symbol of the vibration adapter. Changing the setting of the vibration adapter by one step causes your AT to react around a third faster.

### Readability

If your application allows, you should reduce the readout increments for the last decimal place. The larger the readout increments (e.g. steps of 5 instead of 1), the more rapid the operation of your AT balance (see Section 4.4).

### Automatic stability detection

Your AT achieves stability quicker if you reduce the stability detection. If you select, for example, stage 1 (*ASD -1-*) instead of stage 6 (*ASD -6-*), the balance releases the weighing result as stable decidedly more quickly (see Section 4.4).

### Glass draft shield, Inner draft shield

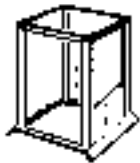

Your AT operates faster if you open the draft shield to load the balance only as much as necessary. So that excellent weighing results can also be achieved fast under difficult weighing conditions, you can also use an inner draft shield. (Order number 210270). The disturbing effects of any incoming drafts in the weighing chamber are thus lessened (see Section 2.1).

Always select the fastest setting in the menu or configuration register that your application allows. You can naturally combine all measures and hence produce a marked increase in the weighing speed of your AT.

## 7.3 What happens if...?

### ...the display remains completely blank?

Possible causes are:

- no power line voltage
- power cable not connected
- wrong power line voltage

Check and if necessary rectify the specified error sources. If the balance does not function after switching on with the «On/Off» key, contact METTLER TOLEDO service.



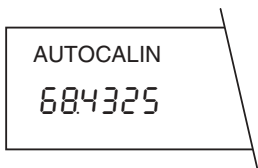

**...during a weighing the audio warning beep sounds and the adjacent symbol appears in the display?**

- If the fully automatic self-adjustment is switched on (see Section 4.4), your AT shows that it wishes to adjust itself (AUTOCALIN = **Automatic Calibration and Linearisation**). But there is no need for you to interrupt your work for this. Your AT will wait until you have not worked with the balance for about 5 minutes and will then adjust and linearize itself. During this process, the symbol "AUTOCALIN" flashes.

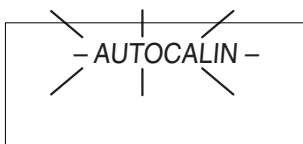

You also have the possibility, however, to trigger the adjustment immediately with a keystroke. Your method of procedure is described in Section 5.4. The symbol in the display fades when adjustment is ended.

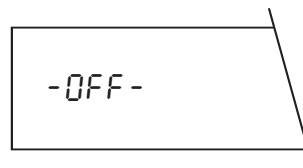

**...after connection to the power supply the adjacent display appears?**

- You have disconnected your AT from the power supply without previously switching it off by lifting the «On/Off» key, < or a power outage has interrupted the balance operation. After reconnection to the power supply or when the power is restored, the balance is not switched to standby.
- Press the «On/Off» key to switch the balance on again. An extended internal self-test is then run with display of the model designation and the software version. All display segments light up briefly and your AT is then ready for weighing again.

### ...the display shows overload or underload?



- **Overload** is displayed when the weight of the loaded weighing sample is larger than the weighing range.

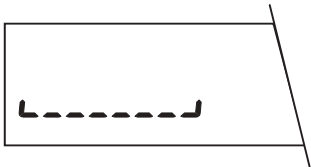

- **Underload** is displayed when the weighing range is not reached. This applies when the weighing pan is missing, or the weighing pan touches the draft cover and no longer has unrestricted movement. In this case switch the balance off, position the weighing pan correctly and then switch your AT on again.

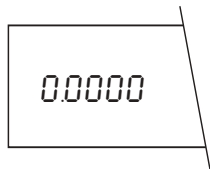

### ...the display “0.0000” flashes?

Zero is not defined:

- Place the weighing pan on the balance.
- Remove the load from the weighing pan.

### ...the glass draft shield is somewhat difficult to open in manual operation?

- Free the motor coupling by gently jerking the draft shield slider back and forth.

### ...the graphic indicators suddenly disappear?

- Depending on the setting in the configuration register, the graphic indicators are either displayed permanently or only for a few minutes after the balance has been switched on (see Section 4.5).

**...the balance returns automatically from the menu or the configuration register to the weighing mode?**

- You have selected the menu or the configuration register and not pressed a key for 1 minute. Your AT thus assumes that you do not wish to make any changes and returns to the weighing mode.

**...no weighing results or nonsensical characters are printed out on the attached printer?**

- To ensure correct functioning of the attached printer, different settings have to be made in the configuration register, including values for the data transmission and the parity (see Section 4.6). Information regarding the correct settings can be found in the handbook of your printer.

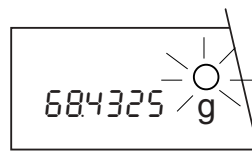
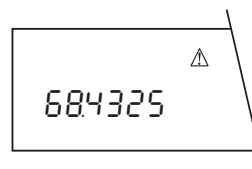

**...the triangle symbol appears in the display?**

- You have pressed the «Print» key. Your AT signals that it is ready to transmit a released weighing result (stability indicator faded) via the interface (e.g. to a printer).

**...a flashing circle appears above the weight unit?**

- If a weighing result has been transmitted via the interface (with the «Print» key), in fully automatic operation the draft shield opens automatically. So that you can check the result or if need be note it down, the display remains “frozen” for 5 seconds, and this is indicated by the flashing circle.

## 7.4 What does this error message mean?

- Error messages in the display draw your attention to faulty operation, namely that the balance was not able to perform a procedure properly. Error messages are supported by an audio signal (“twitter”).

### Wrong or missing reference weight

- If one of the application units percent (%) or piece (*Stk* or *PCS*) has been selected as weight unit 2, the balance must have a reference weight available. The following errors can appear:

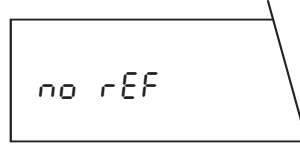

no rEF

- No reference weight has been loaded.

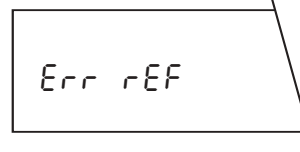

Err rEF

- A wrong reference weight has been loaded.
- The balance returns automatically to the weighing mode.

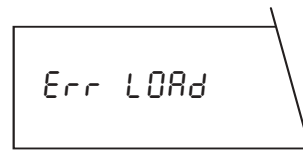

Err LOAD

### The weight lies outside the tolerance

The following causes could be responsible:

- a wrong external adjustment weight.
- the weighing pan is loaded during the adjustment.

The adjustment procedure is aborted automatically and the balance returns to the weighing mode.

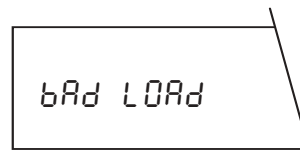

bAd LOAD

- You have started the adjustment test. A weighing sample is still on the weighing pan. Remove it.

Err. unStb

### Fault in the adjustment

- The adjustment procedure of the balance has been disturbed.
- The adjustment is automatically aborted and the balance returns to the weighing mode.

Err. tIME

### The wait time of 1 minute has run out

This could have the following causes:

- You have set the automatic stability detection (ASD) at a too high stage. After pressing the «Print», «Re-Zero» or «Set» key (*with %*, *Stk* or *PCS*), stability is not reached within 1 minute.
- The weight for the external adjustment has not been loaded.

- A wrong weight has been loaded.

The corresponding procedure is aborted automatically and the balance returns to the weighing mode.

## 7.5 What does this term mean?

We have “translated” the most important technical terms for you. References (in italics) show you the section(s) in which you can find further information.

### Adjustment

Matching the balance to a reference weight. Adjustment, see also proFACT. *Sections 4.4, 5.4 and 5.5*

### Adjustment test

Test function which can be called up in the menu to allow **checking** of the adjustment without adjustment actually being performed. *Section 5.5*

CAL tEST

**Ambient conditions**

Local conditions at the location of the balance. The following local conditions can lead to display errors during weighing: unsuitable location, changes in the temperature, atmospheric humidity or the atmospheric pressure, magnetic fields, electrostatic forces, vibrations, drafts caused by air conditioning.

*Section 7.1*

**Analytical balance**

Balance with a readability of 1 d (1 digit) = 0.1 mg.

**Analytical range**

Weighing range with a readability of 1 d (1 digit) = 0.1 mg.

*Section 2.4*

**Application unit**

Unit selectable in the configuration register that is used for applications in which not only the weight, but also a quantity derived from it (piece, percent) is determined and displayed.

*Sections 4.5, 5.2 and 5.3*

**Automatic door function**

Automatic opening and closing mechanism for the glass draft shield that ensures that the balance and the draft shield are always in the correct position for the next weighing step.

*Section 3.4*

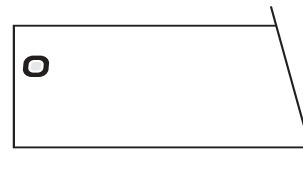
**Automatic stability detection**

Continuous automatic check of the weight value for stability. The weight display is considered stable when its change with time lies within a preset limit. Different stages can be configured by the user and correspond to various limits. The stability of the display is attained when the stability detection symbol in the upper left corner of the display fades.

Also with Re-Zero (taring) the display is set to zero only when stability has been achieved.

*Section 4.4*

**Autozero**

Automatically corrects the zero display if drifting occurs or the weighing pan is contaminated.

*Section 4.4*

**Baud rate**

See “Data transmission rate”.

**Bit (Binary digit)**

Unit used for the information content of a communication.

*Section 4.6*

**Coarse range**

Normal weighing range with ten times less resolution than the fine range. See also “Dual-range balances” (semimicro balances) and “DeltaRange® balances”.

*Sections 2.3 and 2.4*

**Configuration**

The sum total of all settings selected for the parameters in the configuration register.

*Section 4*

**Configuration register**

Register with tree-like structure in which operational settings, weight units and much more can be matched to the needs of the user. The configuration register can be protected against inadvertent changes with the aid of the jumper.

*Section 4 and pages 82 and 83*

**Configuring**

Changing the settings in the configuration register.

*Section 4*

**Data transmission rate**

Specifies the rate at which the data are transferred. Also called baud rate: 1 baud = 1 bd = 1 bit/second.

*Section 4.6*

**DeltaRange® balance**

Balance with a fine range recallable at any time over the entire weighing range.

*Section 2.4*

**DeltaTrac®**

Dynamic graphic indicator with 60 radial indicators. Displays the used and remaining weighing range. Graphic complement to the alphanumeric display; also suitable for use as a weighing-in aid.

*Sections 2.2 and 5.2*

**Differential weighing**

Determination of the weight of a sample before and after a weight change.

**Digit**

Display unit; a digit corresponds to a display increment of the last decimal place.

- 1 digit = 1d = 0.1 mg in the analytical range
- 1 digit = 1d = 0.01 mg in the semi-micro range

See also "Readability"

*Section 5.5*

**Dispensing**

Fine weighing in of powder or small quantities of liquid.

*Section 3.2*

**Display**

Used for communication between balance and user. Shows weighing results, setting options, etc.

*Front fold-out*



### **Door drive handle**

Device which allows motorized opening of the draft shield.

*Section 2.1*

### **Factory setting**

Settings preselected by the manufacturer in the menu or configuration register for normal applications and ambient conditions. Characterized in the configuration register by an asterisk in the upper left corner of the display. Can be changed by the user, but also reset at any time.

*Sections 3 and 4*

### **Fine range**

Section of the entire weighing range with a ten times greater accuracy, see also “Dual-range balances” (semimicro balances) and “DeltaRange® balances”.

*Sections 2.3 and 2.4*

### **Foot switch**

Available as an accessory in single or twin versions. Control element for zeroing (taring) the display, for triggering the data transmission («Print» key) and for operation of the automatic door function of the draft shield. Frees both hands for operations.

### **Handshake**

Special control lines or data signals for synchronization of the data flow via the serial interface (feedback between sender and transmitter).

*Section 4.6*

### **Interface**

Connector with standardized data transfer between the balance and another component of the system (printer, computer).

*Section 4.6*



\*

**Jumper**

Safety device in the program cassette. Rearrangement of contacts blocks the configuration register and thus protects the stored settings against inadvertent change.

*Section 4.8*

**LCD**

Liquid **C**ystal **D**isplay. Display which does not itself light up but reflects the ambient light.

*Front fold-out*

**Level**

Device which facilitates the horizontal alignment of the balance. Operates on the principle of a spirit level with an air bubble in a liquid. See also "Leveling".

*Section 1.2*

**Leveling**

Horizontal aligning of the balance. Should be performed before startup.

*Section 1.2*

**Linearization**

Adjustment of the balance characteristic curve. To establish the proportionality between the loaded weight and the display. Performed by the AT for every adjustment in the fully automatic self-adjustment and in the automatic adjustment with the built-in adjustment weight.

*Section 4.4*

**Menu**

A menu is generally understood to mean a series of selections which the user can match to his needs. In the menu of the AT the user can match the balance to the ambient conditions, adjust the balance and undertake other adjustments.

*Section 3 and pages 82 and 83*

**Overload/underload display**

Signals the overloading or underloading of the balance through illumination of the horizontal segments in the display.

*Section 7.3*

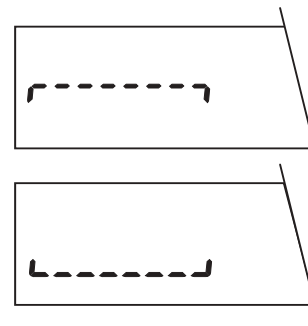

**Parameter**

Part of a sector in the configuration register. Each of the four sectors of the AT contains parameters (e.g. automatic stability detector, readability, etc.).  
*Section 4 and pages 82 and 83*

**Parity**

Checking information in the data transmission.  
*Section 4.6*

**Percent weighing**

Application for the weighing in to a preset reference value (= 100%) and with the possibility to display the deviation in percent.  
*Section 5.2*

**Piece counting**

Weighing application for the determination and display of the piece count of weighing samples of equal weight.  
*Section 5.3*

**proFACT**

Fully automatic adjustment and linearization with two internal weights when necessitated by the operating conditions. proFACT: professional Fully Automatic Calibration Technology.  
*Section 4.4*

**Program cassette**

Cassette with stored microcomputer program needed by the balance for its functioning.  
*Section 4.8*

**Readability**

Smallest, still distinguishable display difference = 1 d (1 digit); for METTLER TOLEDO analytical balances 1d = 0.1 mg.  
*Section 4.4*

**Reference weight**

Representative reference weight. Needed among other things for the performance of percent weighings and piece counting.

- In percent weighings. Reference weight = 100%
- In piece counting: Reference weight = weight of the reference piece number

*Sections 5.2 and 5.3*

**Repeatability**

Consistency of the weighing result in several repetitions on the same balance with the same weighing sample and under identical weighing conditions. It is unnecessary that each individual weighing lies within the limits; rather a statistical function is involved. The repeatability is usually expressed as the standard deviation  $s$  of 10 weighings.

**Resolution (resolving power) of a balance**

See "Readability"

**Re-Zero**

International designation for the zeroing of the display and for the zeroing key. Also used for zero setting, taring and the tare bar, although the definitions are not identical.

*Section 1.3*

**Sector**

Part of the configuration register. The configuration register of the AT comprises four sectors, each of which contains various parameters.

*Section 4 and pages 82 and 83*

**Segment**

The smallest part of a display. The display of a letter or a number comprises several segments.

*Front fold-out*

**Self-test**

After connection to the power supply, the balance automatically performs a test of its functions.

*Section 1.3*

**Semimicro balance (semimicro analytical balance)**

Balance with a readability of 1 d (1 digit) = 0.01 mg = 0.00001 g.

**Semimicro range**

Fine range in dual-range balances with a resolution of 0.01 mg.

**Stability detection**

See “Automatic stability detection”.

**Stabilization time**

Also known as weighing speed. It is defined as the time between the loading of the weighing sample on the weighing pan and the attainment of stability of the weight display (see also “Automatic stability detection”). The stabilization time can be matched to special needs with the vibration adapter being the most important influencing factor.

*Sections 3.3, 4.4 and 7.2*

**Standby**

Wait condition. Balance is in operational readiness (connected to the power supply via the AC adapter), but not switched on, i.e. the display is dark, only the standby symbol is lit up.

*Section 1.3*

**Status indicators**

Symbols that show the most important settings (vibration adapter, weighing process adapter). The symbols can be displayed permanently or for just a few minutes after switching on the balance.

*Section 4.5*

**Tare weight**

Weight of a container, vessel or the packing that should not be taken into account in the weighing.

*Section 1.3*

**Target weight**

See “Reference weight”.

**Taring**

Compensation of tare weights, i.e. setting the display of the balance with loaded tare weight to zero. Often called zeroing, zero setting or re-zero. See also “Re-zero”.

*Section 1.3*

**VFD**

**V**acuum **F**luorescence **D**isplay. Self-illuminating display that is not dependent on the ambient lighting.

*Front fold-out*

**Vibration adapter**

Possibility to adapt the balance to the local conditions prevailing at the weighing station. Set in the menu in the case of the AT.

*Section 3.3*

**Wait condition**

See “Standby”.

**Weighing-in aid**

See “DeltaTrac®”.

**Weighing mode**

Your balance is ready for weighing operations, i.e. it will display the weighing result and is not in the menu, the configuration register or the standby state.



**Weighing process adapter**

Possibility to adapt the balance to special types of weighing; set in the menu.

*Section 3.2*

**Weighing speed**

See “Stabilization time”.

**Weight unit**

Unit (e.g. g, mg, oz, etc.) that can be selected in the configuration register.

*Section 4.5*

**Zeroing**

See “Taring” and “Re-Zero”.

## 7.6 How are weight units converted?

The following table will facilitate the conversion between the weight units available for the AT

	Gram g	Milligram mg	Carat ct/C.M. (metr.) koil	Ounce oz (avdp)	Troy Ounce ozt	Pennyweight dwt
1 g =	1	1000	5	0.03527396	0.03215075	0.6430149
1 mg =	0.001	1	0.005	0.0000352740	0.0000321508	0.000643015
1 ct/C.M. =	0.2	200	1	0.007054792	0.006430150	0.1286030
1 oz =	28.34952	28349.52	141.7476	1	0.9114585	18.22917
1 ozt =	31.10347	31103.47	155.5174	1.097143	1	20
1 dwt =	1.555174	1555.174	7.775869	0.05485714	0.05	1
1 GN =	0.06479891	64.79891	0.3239946	0.002285714	0.002083333	0.041666667
1 tl (HK) =	37.429	37429	187.1450	1.320269	1.203370	24.06741
1 tl (SGP/Mal) =	37.79937	37799.37	188.9968	1.333333	1.215278	24.30556
1 tl (Taiwan) =	37.5	37500	187.5	1.322774	1.205653	24.11306
1 mo =	3.75	3750	18.75	0.1322774	0.1205653	2.411306



Operating instructions METTLER TOLEDO AT balances

		Grain GN	Tael tl (Hongkong)	Tael tl (Singapur) (Malaysia)	Tael tl (Taiwan)	Momme mo
1 g	=	15.43236	0.02671725	0.02645547	0.02666667	0.2666667
1 mg	=	0.01543236	0.0000267173	0.0000264555	0.0000266667	0.000266667
1 ct/C.M.	=	3.086472	0.005343450	0.005291094	0.0053333333	0.053333333
1 oz	=	437.5	0.7574213	0.7500000007	0.7559874	7.559873
1 ozt	=	480	0.8309993	0.8228570	0.8294261	8.294260
1 dwt	=	24	0.04154997	0.04114285	0.04147131	0.4147130
1 GN	=	1	0.001731249	0.001714286	0.001727971	0.01727971
1 tl (HK)	=	577.6178	1	0.9902018	0.9981068	9.981068
1 tl (SGP/Mal)	=	583.3334	1.009895	1	1.007983	10.07983
1 tl (Taiwan)	=	578.7134	1.001897	0.9920800	1	10
1 mo	=	57.87134	0.1001897	0.09920800	0.1	1

## 7.7 Where will I find details of...?

The following index shows you the page number of these instructions on which you will find the information appropriate to a particular theme. The page numbers in bold print refer to the most important information for the specific search word.

Absolute weighing	18	Beeper setting	34
AC adapter	4, <b>53</b>	Below-the-balance weighing	57
Accessories	57	Cleaning	56
Adjustment	<b>30, 46</b> , 48, 66, 67	Configuration register	<b>22</b> , 69
Adjustment mode	<b>31</b> , 47, 49	Data interface	35
Adjustment weight	49	DeltaTrac®	<b>11</b> , 42, 48
Adjustment test	50	DeltaRange® balance	11
Application unit	<b>33</b> , 68	Dispensing	18
Applications	41, 43	Draft shield	8
Automatic door function	<b>20</b> , 68	Drop symbol	17
Automatic door operation	20	Electrostatic charging	58
Automatic stability detection	<b>27</b> , 68	Error message	66
Autozero	<b>29</b> , 69	External adjustment weight	31, 48
		Factory setting	<b>27</b> , 71
		Fine dispensing	18
		Fine range	11, 71
		Glass draft shield	8
		Interface	<b>35</b> , 71
		Jumper	39
		Linearization	<b>30</b> , <b>47</b> , 72

Magnetic weighing samples or containers	59	Self-adjustment, fully automatic	31, <b>46</b>
Manual adjustment	47, <b>48</b>	Self-test	<b>5, 8, 75</b>
Menu	14	Semimicro balance	<b>12, 75</b>
Operational setting	22, <b>26</b>	Setting options	14, <b>22</b>
Overload	64	Stability detection	<b>27, 68, 75</b>
Percent	41	Stabilization time	61, <b>75</b>
Percent weighing	<b>41, 73</b>	Standby	7, 75
Piece counting	21, <b>43, 73</b>	Status indicators	<b>34, 76</b>
Power outage	8, <b>63</b>	Switching off the balance	<b>7, 63</b>
Printer	38, 51	Taring	<b>5, 76</b>
proFACT	<b>30, 46, 73</b>	Underload	64
Program cassette	39, 73	Unstable display	20, <b>58</b>
Readout increment	<b>28</b>	Vibration adapter	<b>19, 76</b>
Reference weight	<b>41, 45, 74</b>	Vibrations	19
Repeatability	28, <b>74</b>	Wait condition	76
Resolution	<b>11, 74</b>	Wave symbol	19
Re-Zero	74	Weighing in	18
		Weighing mode	5, <b>76</b>
		Weighing process adapter	<b>17, 77</b>
		Weighing speed	28, <b>61, 76, 77</b>
		Weight unit	<b>32, 33, 40, 77</b>

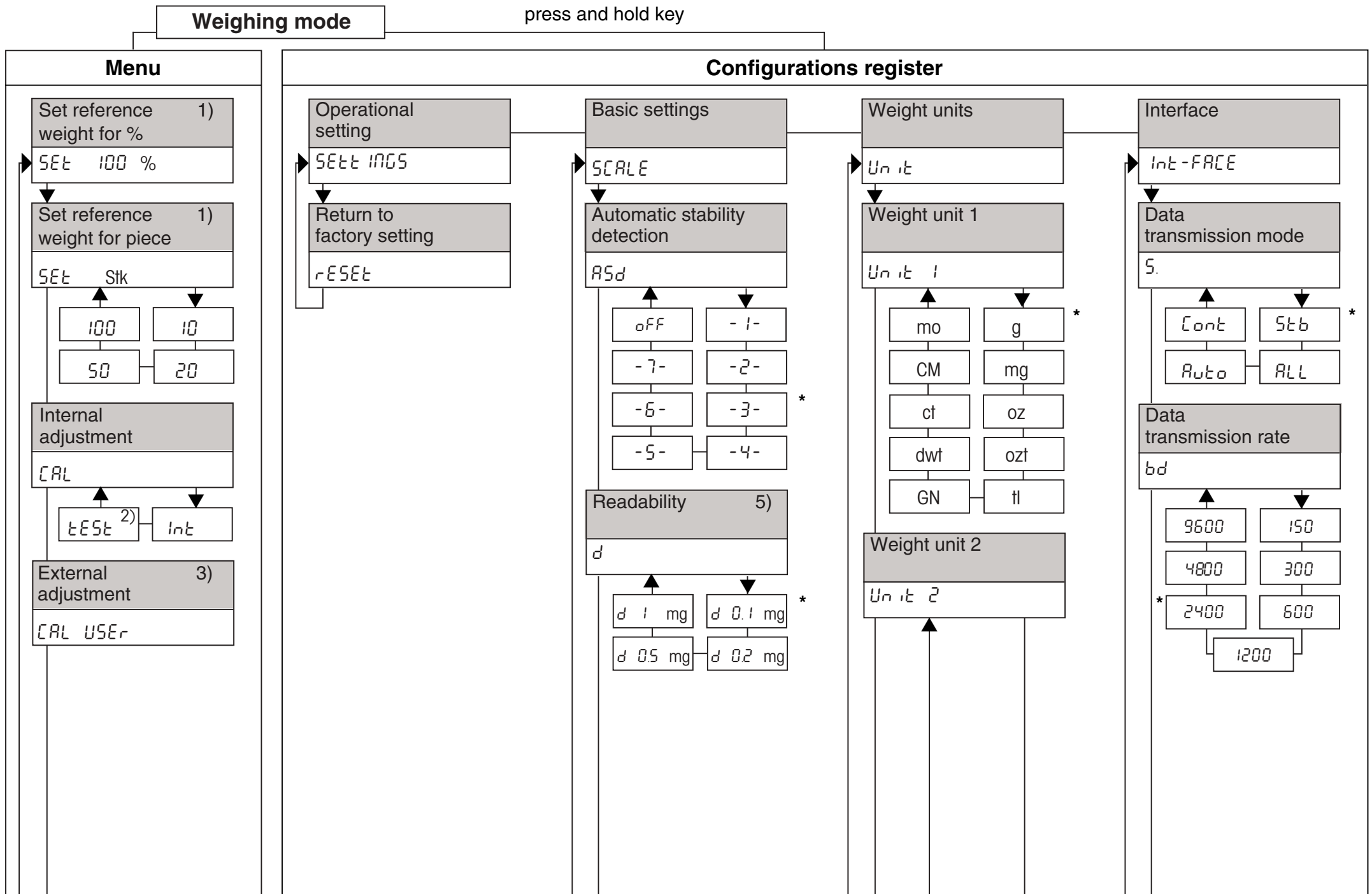

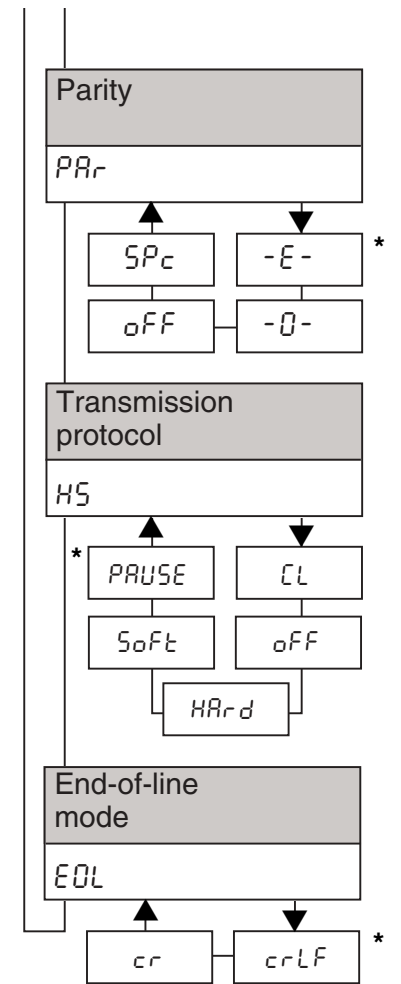
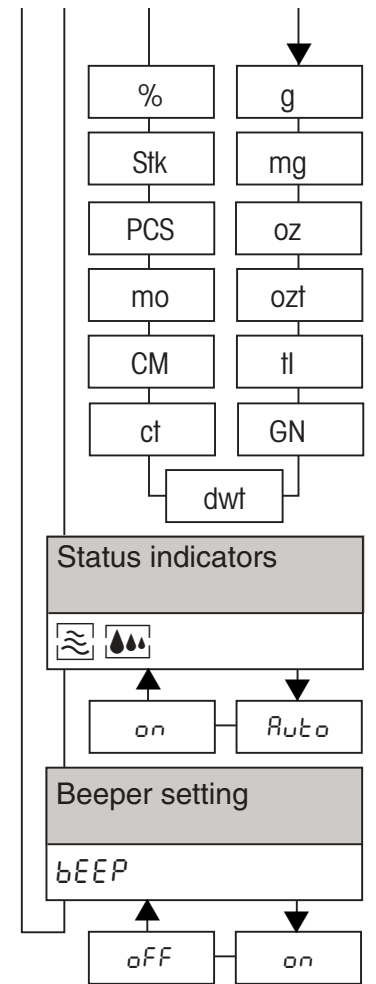
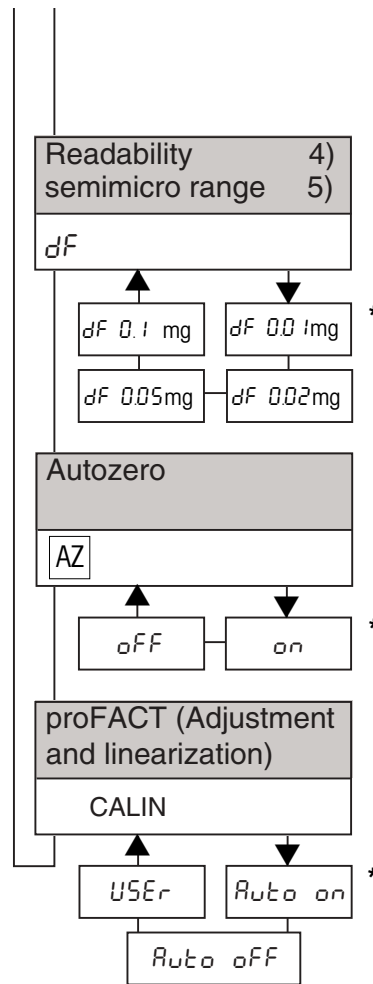
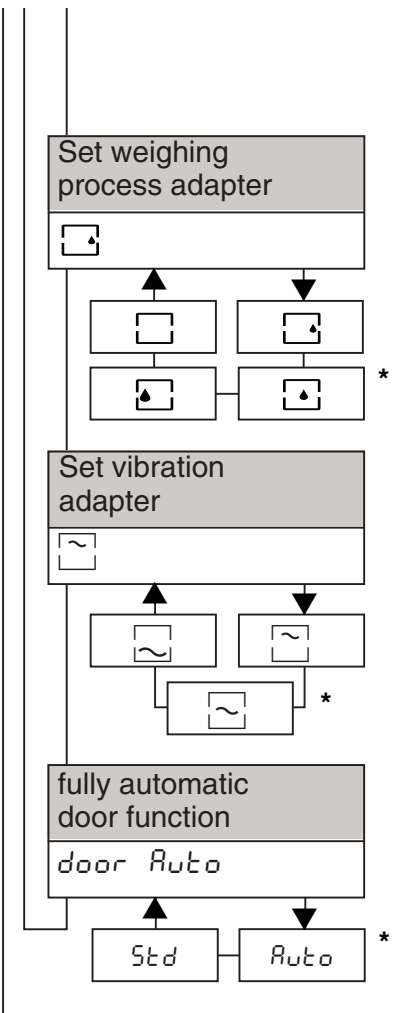

Menu	
	Selection of the menu Selection of the menu options
	Selection of the settings
	Cancellation of the changes and return to the weighing mode
	Storage of the current menu and return to the weighing mode
	Switching off the balance by pressing key upward

Configuration register	
	Selection of the configuration register Selection of the sectors
	Selection of the parameters
	Selection of the settings
	Cancellation of the changes and return to the weighing mode
	Storage of the current configuration and return to the weighing mode

- 1) Appears only if weight unit 2 is set in the configuration register to percent (%) or piece (Stk or PCS).
  - 2) Appears only if the internal adjustment (Auto Off) is set in the configuration register.
  - 3) Appears only if the external adjustment (USEr) is set in the configuration register.
  - 4) Appears only with semimicro and DeltaRangeR balances.
  - 5) The following appears with the AT20:  
d = 0.01 mg\*, 0.02 mg, 0.05 mg, 0.1 mg / dF = 2 µg\*, 5 µg, 10 µg  
The following appears with the AT460 DeltaRange®:  
d = 1 mg\*, 2 mg, 5 mg, 10 mg / dF = 0.1 mg\*, 0.2 mg, 0.5 mg, 1 mg
- \* Factory setting

**Technical specifications  
(after a warm-up time of at least 120 min.)**

Modell	AT21 Comparator	AT20	AT201	AT261 DeltaRange® 60g DeltaRange®   200g		AT200	AT400	AT460 DeltaRange® 60g DeltaRange®   400g	
Readability	1 µg	2 µg	0.01 mg	0.01 mg	0.1 mg	0.1 mg	0.1 mg	0.1 mg	1 mg
Weighing capacity	22 g	22 g	205 g	62 g	205 g	205 g	405 g	62 g	405 g
Taring range (by subtraction)	0...22 g	0...22 g	0...205 g	0...205 g	0...205 g	0...205 g	0...405 g	0...405 g	0...405 g
Repeatability (s) full load	2 µg	4 µg	0.04 mg	0.04 mg	0.05 mg	0.07 mg	0.15 mg	0.15 mg	0.3 mg
Repeatability (s) 0...50 g			0.015 mg	0.015 mg		0.04 mg	0.05 mg	0.05 mg	
Linearity	± 6 µg	± 10 µg	± 0.12 mg	± 0.08 mg	± 0.15 mg	± 0.15 mg	± 0.5 mg	± 0.5 mg	± 1.4 mg
Linearity within 500 mg <sup>1)</sup>	± 4 µg	± 6 µg		± 0.03 mg					
Linearity within 10 g <sup>1)</sup>			± 0.03 mg	± 0.03 mg					
Stabilization (typical)	14...18 s	10...14 s	10...14 s	8...12 s	3...5 s	3...5 s	4...6 s	4...6 s	3...5 s
Built-in adjustment weights	2x10 g	2x10 g	2x100 g	2x100 g		2x100 g	2x100 g	2x100 g	
Adjustment proFACT	Fully automatic motorized self-adjustment with two built-in weights. The accuracy of the adjustment depends on the geographic location and the height above sea level.								
Adjustment with external weight:	20 g	20 g	200 g	200 g		200 g	400 g	400 g	
Display with DeltaTrac®	LCD (liquid crystal)					VFD (Vakuumfluoreszenz)			
Display sequence	0.2...0.4 s variable								
Sensitivity: - Temperature drift <sup>1) 2)</sup> - Long-term stability <sup>3)</sup>	±1.5 ppm/°C with self-adjustment proFACT: ±1.5 ppm								
Linearization	Automatic self-linearization of the weighing curve (simultaneously with motorized adjustment proFACT)								
Data interface	CL and RS232C, bidirectional, built in as standard, all lines galvanically separated.								
Glass draft shield	No hindering guideways; automatic motorized opening or at a keystroke.								
Inner draft shield	Standard		Accessory						
Equipment designed test conditions Power supply (national codes)	P: 115 V or 230 V, admissible voltage fluctuation: -20% +15%, frequency 50/60 Hz, max. power consumption 15.5 W. S: 12.8 V=, 6.5 V=, 10.8 V=, 16.7 V= Pollution degree 2. Overvoltage category II. Temperature: 5...40 °C. max. relative atmospheric humidity: 80% for temperatures up to max. 31 °C linearly decreasing to 50% at 40 °C. Height: 6000 m. Use only indoors in closed rooms.								
Weighing pan with feedthrough for below-the-balance weighing	ø 28 mm suspended	ø 32 mm	80x80 mm; stainless steel						
Measures Weight	Free height above weighing pan 239 mm, Balance housing 241x433x289 mm (W x L x H), power supply 115x140x53 mm (W x L x H) Balance 9.3 kg, AC adapter 1.2 kg								

<sup>1)</sup>: In the temperature range 10...30 °C    <sup>2)</sup>: 1 ppm = 1/1'000'000 (relative to the current weight display)    <sup>3)</sup>: Sensitivity deviation / year with self-adjustment proFACT switched on