



ENGLISH

Issue 1

OPERATOR
GUIDE

74010121 GB

Thermo Shandon

Thermo Shandon Limited is an ISO 9001 and TickIT Accredited Company.

Thermo Shandon makes every endeavour to ensure that the information contained in its support documentation is correct and clearly stated but does not accept responsibility for any errors or omissions. The development of Thermo Shandon products and services is continuous. Make sure that any published information that you use for reference is up to date and relates to the status of the product. If necessary, check with Thermo Shandon or your local Thermo Shandon representative.

© 1997 Thermo Shandon Limited. All rights reserved.

This manual may not, in whole or in part, be copied, photocopied, reproduced, translated, or converted to any electronic or machine readable form without prior written consent of Thermo Shandon Limited.

OPERATOR GUIDE

LIST OF CONTENTS

	Page
WELCOME Safety	1.1
DESCRIPTION Operating Principles; Construction	2.1
INSTALLATION INSTRUCTIONS	3.1
SETTING UP	4.1
CONTROL PANELS	5.1
PROGRAMMING To Enter; To Start; To Save; To Run; To View; To Repeat; To Stop.	6.1
OPERATING	7.1
CLEANING and MAINTENANCE	8.1
TROUBLE SHOOTING Equipment Checks, Alarms.	9.1
SPECIFICATION AND PARTS LIST	10.1
WARRANTY STATEMENT AND CERTIFICATE OF CONFORMITY	11.1
INDEX	12.1
APPENDIX 1 Methodology Guidelines	

WELCOME

1.1 INTRODUCTION

1.1.1 Welcome to the Cytospin® 3 Cell Preparation System. Designed and made with care, Cytospin® is safe to use, simple to operate, and easy to maintain.

1.1.2 This manual gives instructions for its correct operation and use. The number by the side of each illustration is the same as the paragraph number of its associated text.

1.2 SAFETY

1.2.1 Thermo Shandon instruments are designed to operate safely and consistently for many years. However, incorrect actions by a user may damage the equipment, or cause a hazard to health. It is important for you to know that:

- i The instrument weighs approximately 18 Kilograms (39 3/4 lbs); if necessary, get help to move or lift it.
- ii Dangerous voltages are contained inside. Disconnect the instrument from the supply, or take appropriate precautions, before you undo any panels or remove any access covers unless instructed otherwise.
- iii Always load and unload the Sealed Head in a biologically safe fume cupboard. Assume that the samples are biologically hazardous.
- iv Use only genuine Thermo Shandon replacement parts should a repair become necessary.
- v Make sure that no fingers or articles of clothing are allowed within the area defined by the frame assembly if the Cytospin® has to be operated while a panel is removed. Components may suddenly move under computer control and cause injury.
- vi Cytospin® is not intended for use with flammable materials or solvents, nor with materials which could be explosive or chemically reactive.
- vii Bioseals and other biosafety components cannot be relied upon as a sole safeguard against contamination by pathogenic micro-organisms.

1.2.2 In compliance with International health and safety guidelines, all our equipment is designed to accepted standards of safety. Its use does not entail any hazard if operated in accordance with the instructions given in this manual. However, you must obey the following safety precautions.

- i All users must read and understand the Operator Guide, and only operate the unit in accordance with the instructions.
- ii Potentially lethal voltages above 110V a.c. or 50V d.c. are present inside the unit. Do not remove any access covers unless specifically instructed to do so by a Thermo Shandon representative.
- iii It is important that normal standards of safety and good laboratory and housekeeping practices are employed. Always use common sense when operating the instrument.
- iv Any problems should be referred to our Service Department.
- v Correct maintenance procedures are essential to ensure safe operation and consistent performance. It is important that the instrument is by serviced by qualified Thermo Shandon service personnel. The purchase of a Maintenance Contract is strongly recommended.



THIS SYMBOL APPEARS IN DOCUMENTS TO WARN THAT INSTRUCTIONS MUST BE FOLLOWED TO ENSURE SAFE AND CORRECT OPERATION.

WARNING A warning is given in the document if there is a danger of personal injury or damage to equipment.

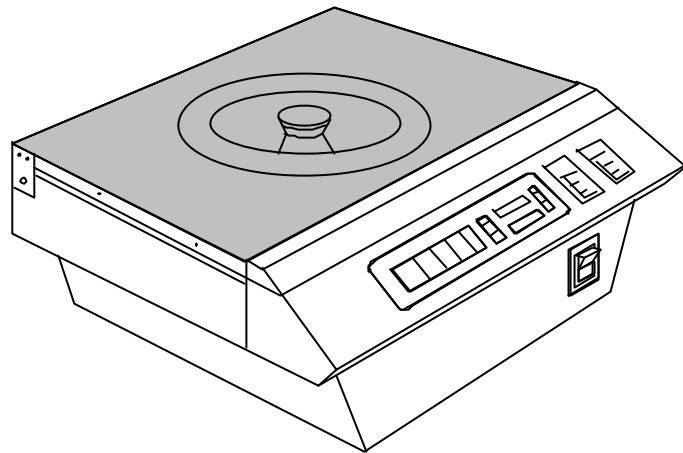

Note

1 Notes give more information about a job or instruction but do not form part of the instruction.

Push-button operations performed by the operator are shown thus: **[PUSH-BUTTON TITLE]**

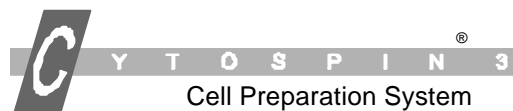

This product meets recognised International standards, and complies with all relevant European Directives, only when used with genuine Thermo Shandon consumables, accessories, and spare parts. For further information please refer to the Declaration of Conformity at the back of this publication.

DESCRIPTION

2.1 OPERATING PRINCIPLES

2.1.1 Cytospin® 3 is designed specifically for use as a cell preparation system that uses centrifugal force to deposit cells onto a slide for microscopical analysis.

2.1.2 Specimens are held in up to 12 sample holders. Each sample holder consists of:

- i a stainless steel Cytoclip™ slide clip(1),
- ii a microscope slide (2), and
- iii disposable Cytofunnel® sample chamber (3) with integral filter card (4)...

OR

separate filter cards with re-usable sample chambers.

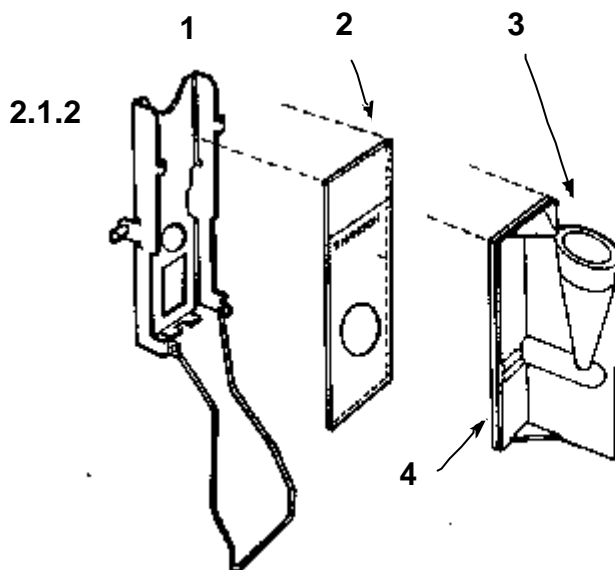

2.1.3 The sample holders fit into a Sealed Head assembly that is removable so that it can be loaded and unloaded in a biologically safe area. The sample holders are held tilted (**Load Position i**) when the instrument is stopped so that the cells in suspension cannot trickle forward and be absorbed by the filter card.

2.1.4 The sample holders tilt forward (**Operating Position ii**) when the Sealed Head rotates so that cells in suspension are forcefully deposited out onto a microscope slide. Excess fluid is absorbed by the filter card.

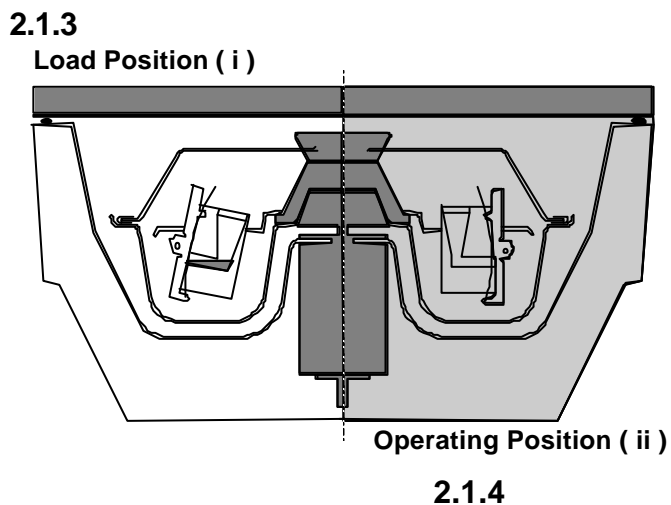

2.1.5 The speed at which the Sealed Head spins, and the duration, can be programmed within the range 200-2000 r.p.m., and 1-99 minutes respectively. The acceleration rates may be High, Medium or Low.

2.1.6 Up to nine programs can be held in the memory of Cytospin®.

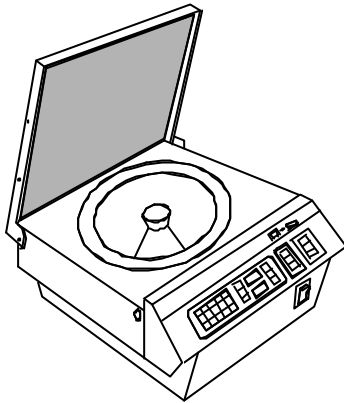

2.2.1

2.2 CONSTRUCTION

2.2.1 Cytospin® comprises a two part metal housing. The Sealed Head rotor assembly fits into a sprung bowl enclosure in the upper part which is closed by a bronzed, see-through, safety cover. The safety cover locks closed during operation.

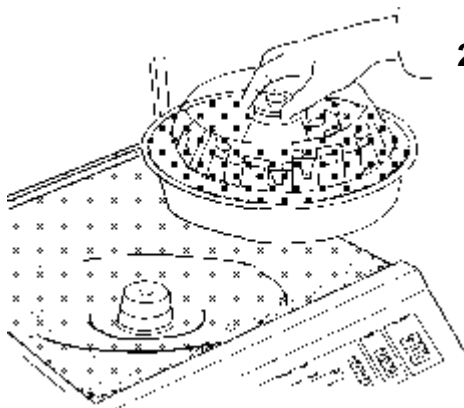

2.2.2

2.2.2 A tapered boss in the sprung bowl supports the Sealed Head assembly. Rotary motion is transmitted to the Sealed Head as the boss rotates.

2.2.3 The Sealed Head assembly has its own bronzed see-through lid to seal the cells in suspension from the environment.

2.2.4 The lower metal housing encloses the electrical power and control equipment; and the motor.

2.2.5 Control of the unit is by membrane type, touch sensitive, switches on the front mounted control panel. Associated displays show the selections made.

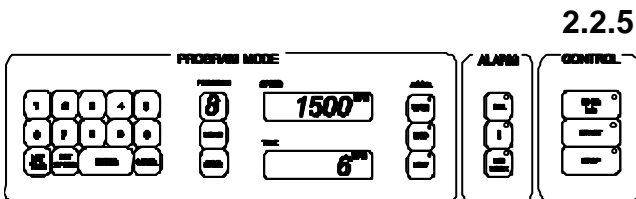

2.2.5

INSTALLATION INSTRUCTIONS

3.1 PROCEDURE

3.1.1 Cytospin® 3 is a precision instrument that must be unpacked and installed with care. Make sure that the detail on the carton corresponds with the Purchase Order before the Cytospin is removed from its carton.

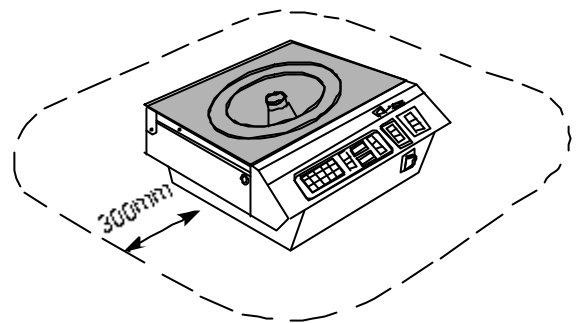

3.1.2

3.1.2 Make sure that the bench or supporting surface on which Cytospin® is to operate is a solid immovable surface that is both flat and level. There must be a clear space around Cytospin®, of at least 300mm (12 in.), that is free of hazardous materials, debris, or personnel. The bench must be stable and capable of supporting a weight of 18 kg (39 3/4 lb), and the environment must be dust free.

Note

- 1 Do not place any paper or protective sheet between the Cytospin® and the supporting surface or the relative motion cut-out may not operate.

3.1.3 If necessary, get someone to help you lift the carton; it weighs approximately 20 kg (44lb). Grip the underneath of the carton firmly to move or lift it. Remove the outer packing. Check that the instrument is not damaged, then grip the underside edges of the upper body and lift the Cytospin out of the carton. Read the label at the rear of the instrument and make sure that the power supply requirements are correct.

3.1.4 Undo the accessories pack. Check that

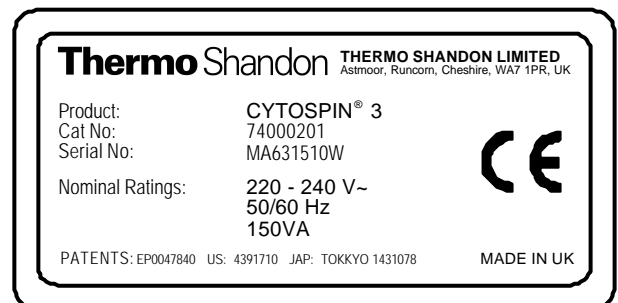

3.1.3

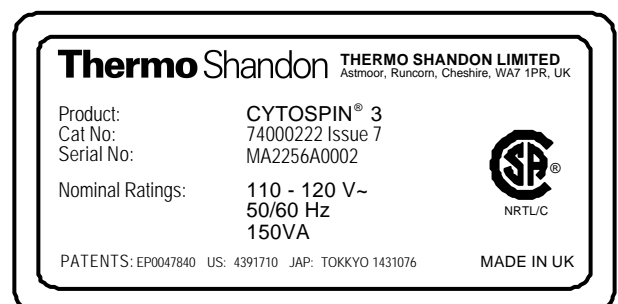

the items are present as listed.

Note

- 1 *Inform your Thermo Shandon dealer immediately if there are any breakages or shortages. Quote the number of your Order, the Invoice, the Delivery Note and its date.*

- 2 *Important information with respect to Parts is printed on the pack in which Cytospin® is supplied. Keep this information in a safe place.*

- 3 *The ~ symbol on the rating plate indicates that the instrument operates on Alternating Current supplies (a.c.)*

WARNING Injury or damage may result if instructions 3.1.5 and 3.1.6 are not followed

3.1.5 Select the appropriate mains lead and fit it into the fused mains input socket at the rear of the unit. Only mains leads less than 3m long should be used with this instrument.

Notes

- 1 *Mains input fuses in instruments that operate from a 110V supply are T2.0 Amp.*

- 2 *Mains input fuses in instruments that operate from a 240V supply are T0.8 Amp.*

- 3 *On 240V instruments the mains supply plug should be fitted with a 5 Amp fuse.*

- 4 *Only a technically competent person should be employed to change fuses.*

3.1.6 Cytospin® 3 is a Class 1 instrument as

defined in IEC1010 and must be protectively earthed. Make sure that the instrument is properly connected to a good Earth/Ground contact, marked as shown.

3.1.6

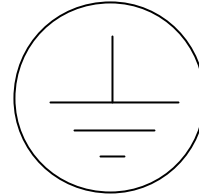

3.1.7 In an emergency it must be possible to interrupt the mains supply from a place either near an exit that is remote from the Cytospin®, or outside the room. Interruption of the supply can be by switching off at the supply socket, or by removing the plug.

3.1.8 Press **O** of the ON/OFF (**I / O**) switch on the front of the instrument to ensure that the instrument is switched off.

3.1.8

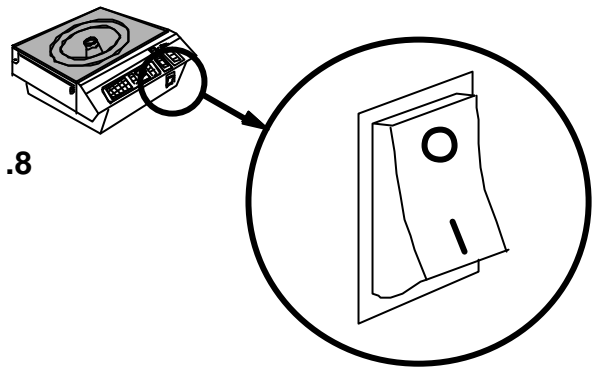

3.1.9 Plug the mains cable into the power supply, and switch on the power supply.

3.1.10 Press **I** of the ON/OFF (**I / O**) switch to switch the instrument ON.

3.1.11 If the 'BAL' and '!' alarm lights flash, lift the front of the instrument approximately 10mm (½ in.) from the bench, then return it to the normal position. This resets the movement detection system.

3.1.11

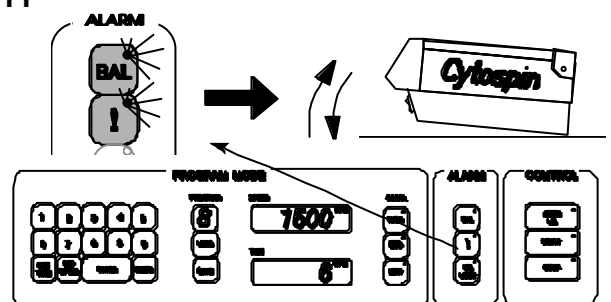

3.1.12 Press [**OPEN LID**] and at the same

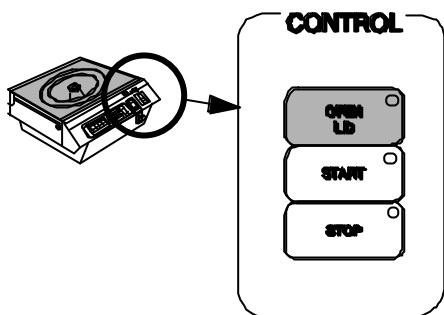

3.1.12

time lift the see-through safety cover from the front.

3.1.13 If power is not available, use the Emergency Release.

3.1.14 To use the Emergency Release, remove the small cap at the left side of the upper housing and insert a rod such as a pencil or screwdriver that is at least 100 mm (4in.) long, or longer, into the aperture.

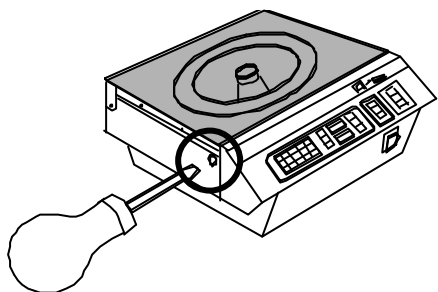

3.1.14

3.1.15 Push the rod inward to release the lock.

3.1.16 Lift the safety cover from the front to open.

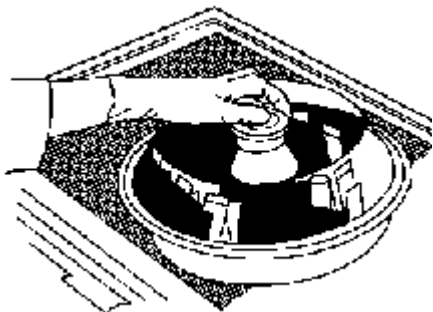

3.1.17

3.1.17 Remove the sponge packing from the top of the Sealed Head assembly then lift the Sealed Head assembly out of the Cytospin®. Remove all the packing pieces.

3.1.18 Pull up the centre button of the lid of the Sealed Head until it 'clicks', then lift off the lid.

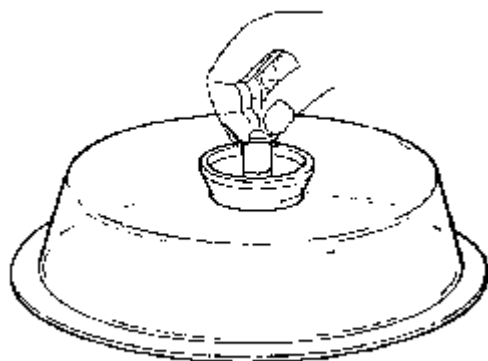

3.1.18

Note

- 1 The lid of the Sealed Head fits snugly in the rubber seal of the base. You may need to tilt the lid gently before you lift it off.

SETTING UP

4.1 MECHANICAL

4.1.1 **To Open the Sealed Head**, pull up the centre button of the Sealed Head lid until it 'clicks'. Remove the lid. If necessary, hold the lid of the Sealed Head with one hand and pull up the centre button with the other.

4.1.1

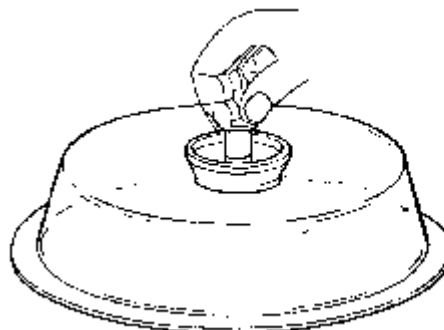

4.1.2 **To Close the Sealed Head**, place the lid in position on the seal of the base. Make sure that the lid sits on the seal correctly. Push down the centre button to secure.

4.1.2

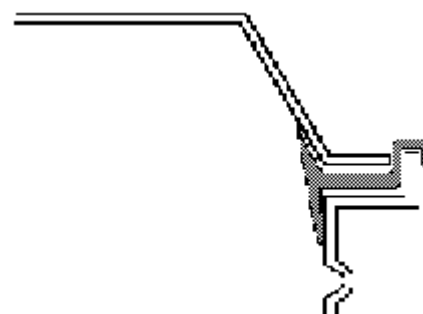

WARNING Do not open or close the Sealed Head assembly while it is installed in the instrument or you may damage the instrument.

4.1.3 **To Load the Cytoclip™** slide clip:

- i fit the glass slide (1), then
- ii fit the filter card (2), then
- iii fit the re-usable sample chamber (3).
- iv Pull up the spring (4) and press it into the two retaining hooks to hold the chamber in place.

4.1.3

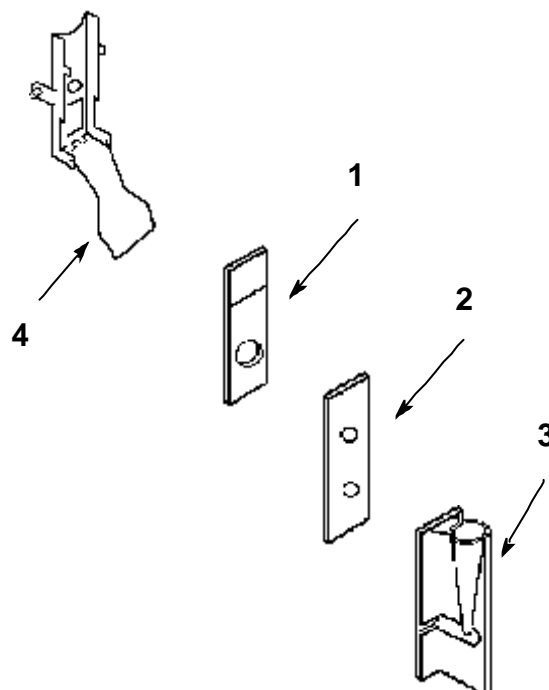

Note

- 1 *The Cytofunnel® is loaded by pipette with between 0.1 ml and 0.5 ml (max.) of cells in suspension.*
- 2 *Detailed instructions for loading the Cytospin® are given in Appendix 1 - METHODOLOGY GUIDELINES*

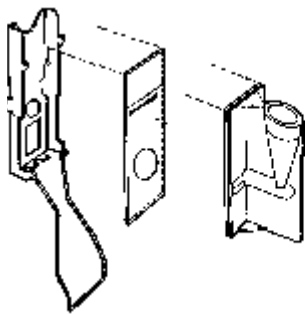

4.1.4

4.1.4 **To Unload the Cytoclip™** hold the slide clip firmly. Push the spring against the slide to release it from the hooks. Move the spring away from the hooks and allow the sample chamber to pop out of the clip.

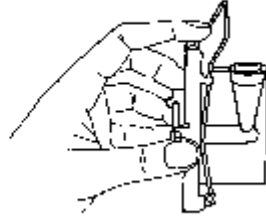

4.1.5

4.1.5 **Disposable Cytofunnels** have filter cards permanently attached which simplifies loading and unloading the Cytoclip™. When unloading, discard the Cytofunnel® directly into the waste receptacle.

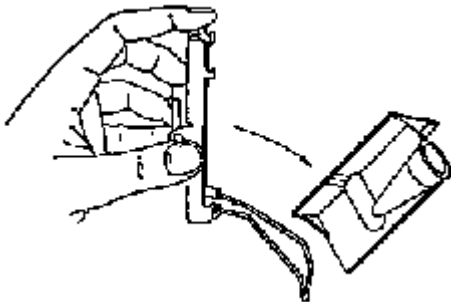

4.1.6 **To Load the Sealed Head** remove the lid and place up to 12 assembled Cytoclips into the slots. Each Cytoclip™ must be free to swing between the tilt and upright positions.

4.1.7 **Make sure that the Cytoclips are evenly distributed so that Cytospin® is not out of balance. Replace the lid and push down the centre button to lock.**

4.1.8 **To Install the Sealed Head** in Cytospin® lift the Sealed Head by its centre knob and place it carefully in position on the tapered boss. Do not wipe the silicone grease from the tapered boss. Close the see-through safety cover.

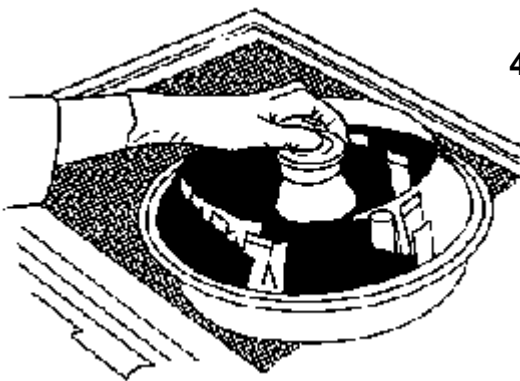

4.1.8

4.1.9 **To Remove the Sealed Head.** Allow rotation to stop then press **[OPEN LID]**. Open the safety cover and remove the Sealed Head to a biologically safe cabinet. Only open the Sealed Head rotor assembly in a biologically safe cabinet.

CONTROL PANEL

5.1 GENERAL

5.1.1 Control of Cytospin® 3 is by membrane type, touch sensitive, push-buttons distributed on three panel sections. The push-buttons light when selected and numerical displays show the current status of the instrument.

5.1.1

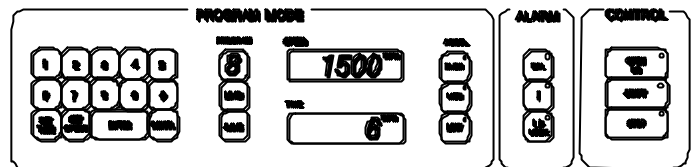

5.1.2 The PROGRAM MODE section of the panel enables the operating parameters for SPEED, TIME and ACCELERation to be set and indicated. Programming is described in Section 6.

5.1.2

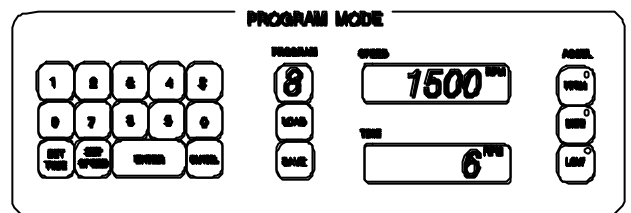

5.1.3 The ALARM section of the panel has indicators that light if a fault occurs.

5.1.3

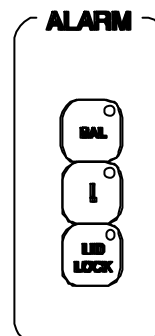

5.1.4 The CONTROL section of the main panel provides means for overall control of the instrument with OPEN LID, START and STOP facilities.

5.1.4

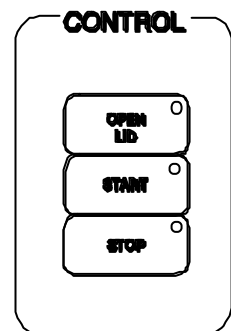

5.2 PROGRAM MODE SECTION

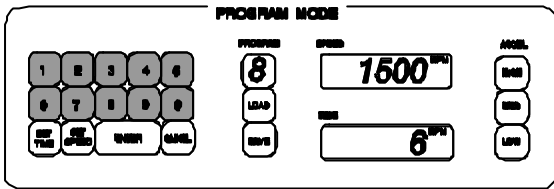

5.2.1

5.2.1 Numeric keys are used in conjunction with the function keys, such as SET TIME, to set a desired parameter.

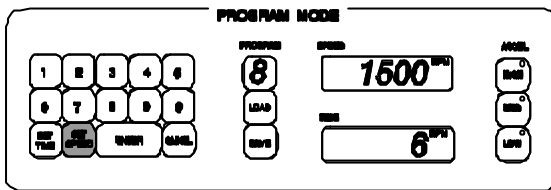

5.2.2

5.2.2 SET SPEED enables an operating speed of between 200 to 2000 r.p.m to be set. The selected speed is displayed in the SPEED display.

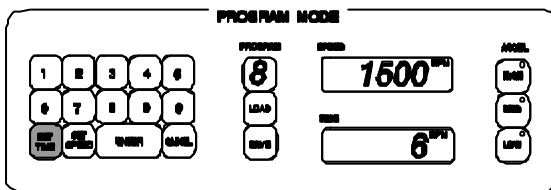

5.2.3

5.2.3. SET TIME is the duration that Cytospin® operates at the set speed. The range available is between 1 and 99 minutes. The actual time selected is displayed in the TIME display.

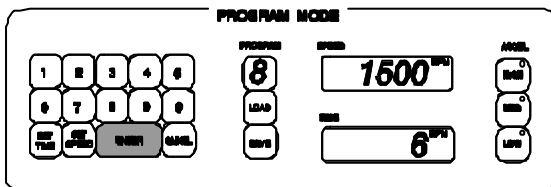

5.2.4

5.2.4 ENTER confirms the key-press selections.

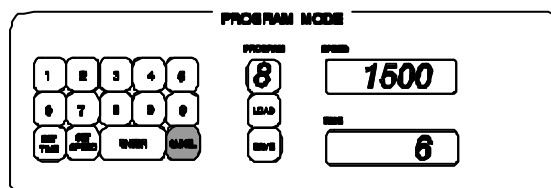

5.2.5

5.2.5 CANCEL removes the previous key-press entry.

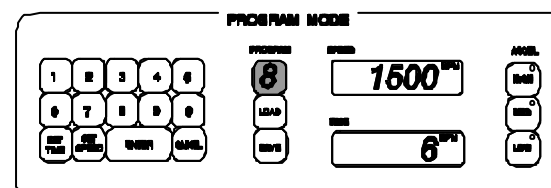

5.2.6

5.2.6 PROGRAM displays a number between one and nine to identify each of the nine individual programs that can be stored.

5.2.7 LOAD is used to select a program from the memory. The speed, time and acceleration settings of the selected program are displayed.

5.2.7

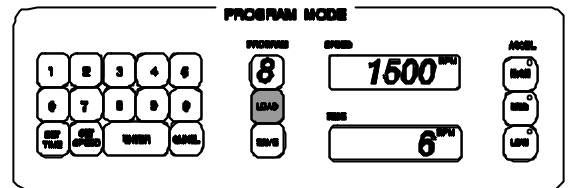

5.2.8 SAVE transfers program parameters to memory. The program can subsequently be loaded to view or to use.

5.2.8

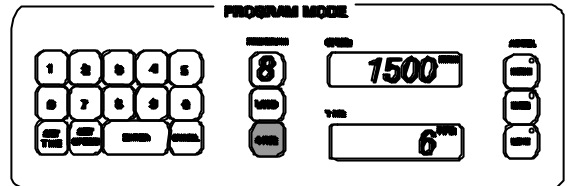

5.2.9 SPEED displays the speed selected for the program being entered.

5.2.9

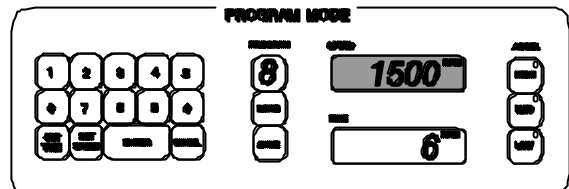

5.2.10 TIME displays the duration of the selected program.

5.2.10

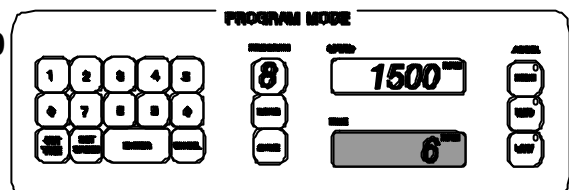

5.2.11 ACCEL selects the rate at which the Sealed Head is accelerated up to the set speed. The options are HIGH, MEDIUM, or LOW.

5.2.11

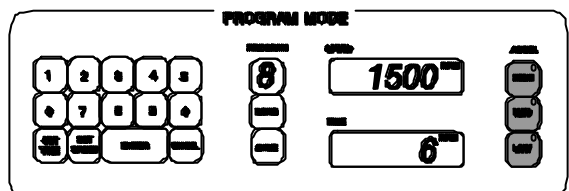

5.3 ALARMS SECTION

5.3.1 The BAL indicator, when lit, shows that the Sealed Head assembly is out of balance.

5.3.1

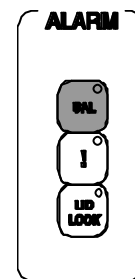

5.3.2 The '!' alarm indicator lights to show that Cytospin® has operated over speed and has stopped for safety.

5.3.2

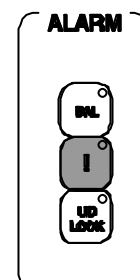

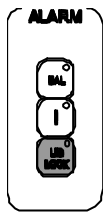

5.3.3

5.3.3 A 'Lid Close' safety sequence looks for correct opening and closing of the safety cover. The LID LOCK indicator lights when

- i the instrument is first switched on,
- ii if the safety cover is not closed correctly.

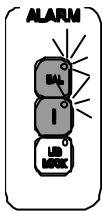

5.3.4

The instrument does not start when LID LOCK is lit. Press **[OPEN LID]**, open and raise the top cover at least 25mm (1"), then close the lid firmly to cancel this alarm.

5.3.4 The BAL and ! alarms flash if Cytospin® is physically moved from its set position for any reason. If Cytospin® is moved while it is switched off, the BAL and ! alarms flash when Cytospin® is next switched on. Tilt the instrument from the front (lift 15mm - ½"), then lower, to cancel this alarm.

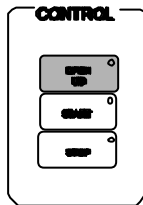

5.4.1

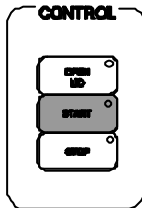

5.4.2

5.4 CONTROL SECTION

5.4.1 **[OPEN LID]** releases the interlock of the safety cover when the Sealed Head is static.

5.4.2 **[START]** starts the selected program.

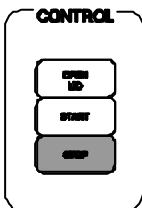

5.4.3

5.4.3 **[STOP]** discontinues the current program.

5.5 AUDIBLE TONES

5.5.2 The tones vary according to status:

Short Tone = Key press acknowledged.

Long Tone = Invalid key press.

Pulsed tone = Alarm condition.

3 second tone = End of Cycle (ready to open);
Cover Open/Close required.

PROGRAMMING

6.1 TO ENTER A PROGRAM

6.1.1 Proceed as follows:

PRESS	RESULT
Power Switch	The displays show '0'; HIGH accel. indicator is lit. Tone sounds. LID OPEN is lit
[OPEN LID]	Open and close lid.
[SET TIME]	The TIME display flashes '0'.
[Number]	The TIME display flashes the number which must be between 1 and 99 minutes.
[ENTER]	The TIME display shows the number.
[SET SPEED]	The SPEED display flashes '0'.
[Number]	The SPEED display flashes the number which must be between 200 and 2000.
[ENTER]	The SPEED displayshows the number.
[HIGH]/ [MED]/ [LOW]	The ACCEL. indicator push-button shows the selection.

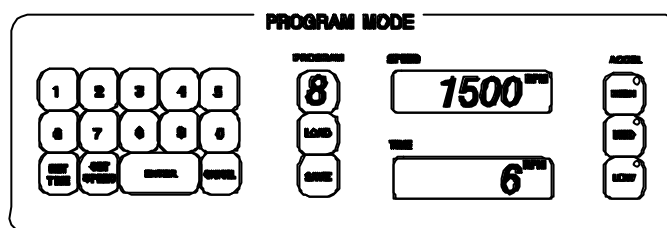

NOTE

- 1 If the set time, or set speed, are outside the limits then the long tone sounder operates and Cytospin® 3 does not accept the entry when [ENTER] is pressed.

6.2 TO START A PROGRAM

6.2.1 When a program is entered press [START] to run the program.

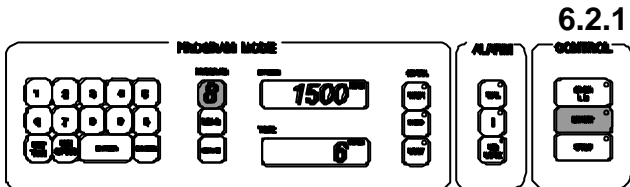

6.3 TO SAVE A PROGRAM

6.3.1 To save an entered program to memory:

- i Press [SAVE].
- ii Enter a program number (1-9) [*n*].
- iii Press [ENTER].

6.3.2 Programs can not be entered or saved while Cytospin® 3 is running.

6.4 TO RUN A PROGRAM FROM MEMORY

6.4.1 To run a program that is stored in memory:

- i Press [LOAD].
- ii Enter a program number (1-9) [*n*].
- iii Press [ENTER].
- iv Press [START].

6.5 TO VIEW A PROGRAM IN MEMORY

6.5.1 To view a program that is held in the memory:

- i Press [LOAD].
- ii Enter a program number (1-9) [*n*].

6.6 TO REPEAT A PROGRAM

6.6.1 Install the loaded Sealed Head in the Cytospin® and press **[START]**. It may be convenient to load a second Sealed Head in a biologically safe area while the first is in use.

6.6.2 Swap the Sealed Head units at the end of a completed cycle. Press **[START]** to repeat the program.

6.6.2

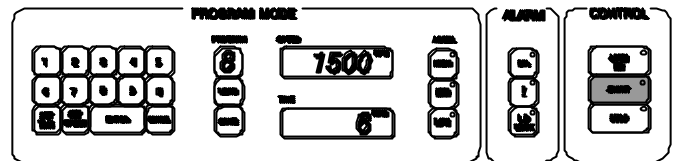

6.7 USING 'CANCEL'

6.7.1 Press **[CANCEL]** to cancel the last keystroke entry.

6.7.1

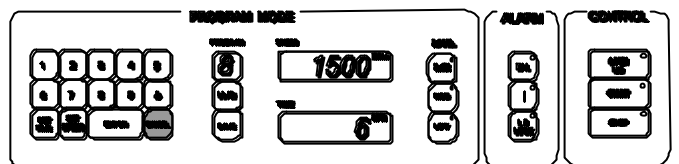

6.8 TO STOP A PROGRAM

6.8.1 Press **[STOP]** to terminate a program before its set time. The STOP indicator lights and the SPEED display shows the Sealed Head losing speed.

6.8.1

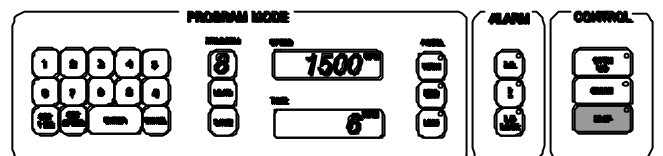

6.8.2 When the speed of the Sealed Head drops below 50 r.p.m. the SPEED display flashes '50' until the Sealed Head is stationary. The 'End of Cycle' sounder then operates.

6.8.2

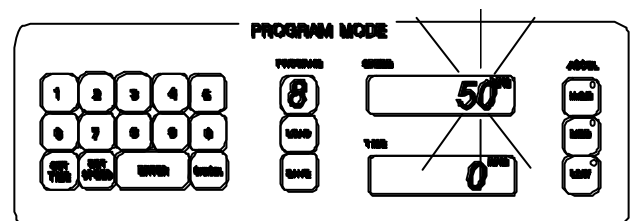

6.8.3 The safety cover remains locked and all pushbuttons of the control panel are disabled until the Sealed Head is stationary.

6.8.4 The control panel is re-enabled after the 'End of Cycle' tone.

OPERATING

7.1 INTRODUCTION

7.1.1 Cytospin® 3 uses centrifugal force to deposit a monolayer of cells in a defined area on glass slides. It effectively by-passes the difficulties normally associated with depositions obtained by direct smear or filtration.

7.1.2 Maximum protection for the operator is ensured by completely containing potentially hazardous specimens in a Sealed Head assembly.

7.1.3 Good laboratory practice requires the use of a biological safety cabinet for loading and unloading the Sealed Head. The Sealed Head should be returned to the cabinet after spinning, before it is opened.

WARNING The use of a biologically safe cabinet when loading or un-loading the Sealed Head is particularly important if the samples under investigation contain, or could contain, pathogenic micro-organisms.

7.1.4 Pencil marking of frosted end slides is a common method for identifying samples and is a recommended practice that takes into account the expected use of the slide.

7.1.5 The instrument should be regularly cleaned, disinfected and sterilized as described in Section 8.

7.1.2

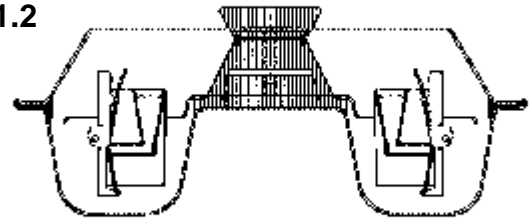

7.1.4

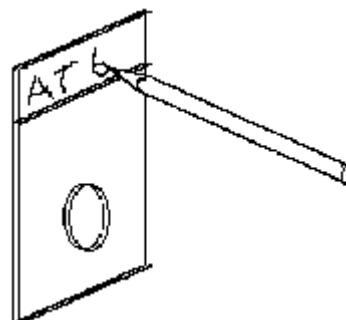

CYTOSPIN 'g' FORCES	
SPEED (r.p.m.)	FORCE (g)
100	1.13
150	2.54
200	4.52
250	7.06
300	10.16
350	13.83
400	18.06
450	22.86
500	28.23
550	34.15
600	40.65
650	47.70
700	55.32
750	63.51
800	72.26
850	81.57
900	91.45
950	101.90
1000	112.90
1050	124.48
1100	136.61
1150	149.32
1200	162.58
1250	176.41
1300	190.81
1350	205.77
1400	221.29
1450	237.38
1500	254.03
1550	271.25
1600	289.03
1650	307.38
1700	326.29
1750	345.77
1800	365.81
1850	386.41
1900	407.58
1950	429.32
2000	451.62

7.1.6 Each laboratory has its own techniques for preparing cells. The accompanying Table - CYTOSPIN 'g' FORCES - provides helpful information regarding the forces generated in Cytospin® 3. The 'g' forces quoted apply at the face of the slide that receives the cells.

7.2 METHODOLOGY GUIDELINES

7.2.1 The paper:

Use of the Cytospin for Hematology and other Clinical Microscopy Specimens,

prepared for Shandon Scientific by Nicky Sherwood, MT (ASCP) and Joanne Cornbleet (MD) of the Clinical Hematology Laboratory, Stanford University Medical Center, is included in English as Appendix 1 at the back of this manual.

7.3 TO RESET CYTOSPIN®

7.3.1 If the **BAL** alarm lights while Cytospin® is operating,

- i the program terminates and the pulsed tone alarm sounds (the figure in the PROGRAM display changes to a diagnostic code and should be ignored).
- ii the alarm sounds until rotation ceases, and the Sealed Head is stationary.
- iii use the power ON/OFF switch to switch the instrument OFF then ON again.
- iv use **[OPEN LID]** to release the safety cover. Remove the Sealed Head to a biologically safe cabinet before opening it. Check that the load is correctly balanced and evenly distributed.

- v Close the Sealed Head assembly before you remove it from the biologically safe cabinet. Load the Sealed Head unit in the Cytospin® and run the program again.

7.3.2 If **BAL** and **!** both flash, lift the front of the instrument approximately 15mm (½ ins) from the bench then return it to its set position. (see 5.3.4)

7.3.2

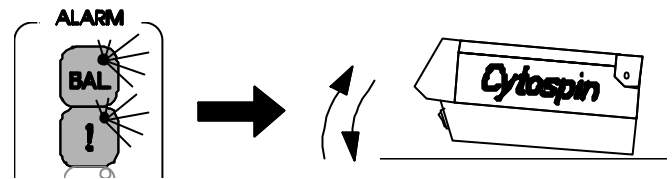

7.3.3 If the **!** alarm indicator lights while the Cytospin is operating:

- i the program terminates and the pulsed tone alarm sounds (the figure in the PROGRAM display changes to a diagnostic code and should be ignored).
- ii the alarm sounds until the Sealed Head is stationary.
- iii use the power ON/OFF switch to switch the instrument OFF then ON again.
- iv use **[OPEN LID]** to release the safety cover. Check that the Sealed Head assembly is installed correctly. If the alarm persists contact your Thermo Shandon Service department.

7.3.4 If **LID LOCK** is lit

- i press **[OPEN LID]** and open the safety cover at least 25mm (approximately 1in.). Close the safety cover and try again.

Note

1 *Cytospin® is normally kept switched on and ready for use. Each time the Sealed head is installed, the safety system detects the opening and closing of the safety cover in the correct sequence and allows Cytospin® to start when **[START]** is pressed.*

2 *If the Sealed Head is installed before Cytospin® is switched on, the safety system cannot detect the correct safety cover opening and closing sequence so **[START]** is disabled and the LID LOCK alarm lights.*

CLEANING AND MAINTENANCE

8.1 GENERAL

8.1.1 Cytospin® is designed for easy maintenance and most fixed components such as the Safety Cover, the Bowl Liner, the Control Panel and the metal housing are cleaned using a proprietary mild detergent solution applied with a soft cloth.

8.1.2 All components and accessories that are likely to become contaminated are also easily cleaned with proprietary mild detergent solutions after sterilization. It is recommended that the suggested methods for sterilization are used.

8.2 RECOMMENDED MATERIALS

8.2.1 Make sure that the active ingredients of any cleaning materials or disinfectants that you propose to use are compatible with the materials used in the construction of Cytospin® and its accessories. If you are not sure, please check with Thermo Shandon service department first.

8.2.2 Most proprietary disinfectants in common laboratory use, such as Clorox®, or commercial disinfectants diluted with 0.3% bicarbonate buffer at 7.0 to 8.0 pH, should be suitable.

8.2.3 Allow disinfectant to contact a contaminated surface for at least one hour, where practicable, to ensure sterilization. **Twenty hours exposure is required to destroy spores of Bacillus subtilis 1.**

WARNING

Always wear protective gloves when you clean or sterilize Cytospin® to protect yourself against infection or the effects of chemicals.

WARNING

Do not clean or sterilize by methods that are not recommended by Thermo Shandon.

WARNING

Do not use any chemicals that interact with materials of manufacture. If in doubt, check with Thermo Shandon Service department.

WARNING

Remove the mains plug from the supply socket before you clean the fixed components of the instrument.

WARNING

Phenol and Hypochlorites in strong solution will damage the instrument and its accessories.

WARNING

Do not use abrasive compounds or metal components to clean Cytospin® or its components and accessories.

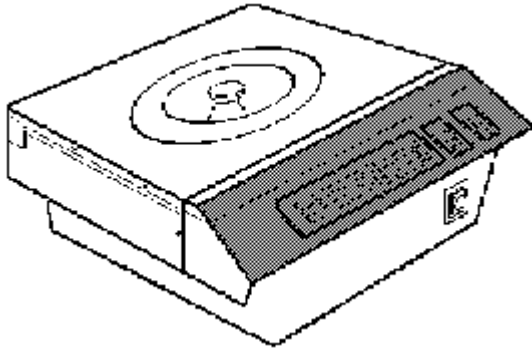

8.3.1

8.3 ROUTINE MAINTENANCE

8.3.1 FRONT PANEL

Note

- 1 *Disconnect Cytospin® from the mains supply.*

FREQUENCY

Weekly or after spillage

CLEAN: Use warm soapy water on dampened cloth or sponge.

Apply 10% commercial bleach in water on dampened cloth or sponge.

Finish with liquid spray or furniture polish.

AVOID Abrasive powders.
Xylene, toluene or similar solvents.

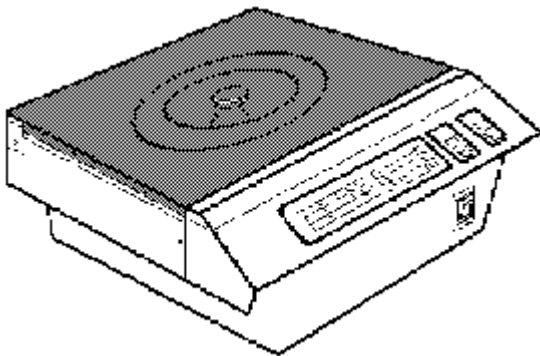

8.3.2

8.3.2 SAFETY COVER

Note

- 1 *Disconnect Cytospin® from the mains supply.*

FREQUENCY

Daily or after serious spillage

CLEAN: Use warm soapy water on dampened cloth or sponge.

Apply 10% commercial bleach in water on dampened cloth or sponge.

Finish with liquid spray or furniture polish.

AVOID Abrasive powders.
Xylene, toluene or similar solvents.

8.3.3 BOWL LINER

Note

- 1 *Disconnect Cytospin® from the mains supply.*

FREQUENCY

Weekly or after spillage

CLEAN: Use warm soapy water on dampened cloth or sponge.

Apply 10% commercial bleach in water on dampened cloth or sponge.

AVOID Abrasive powders.
Xylene, toluene or similar solvents.

8.3.3

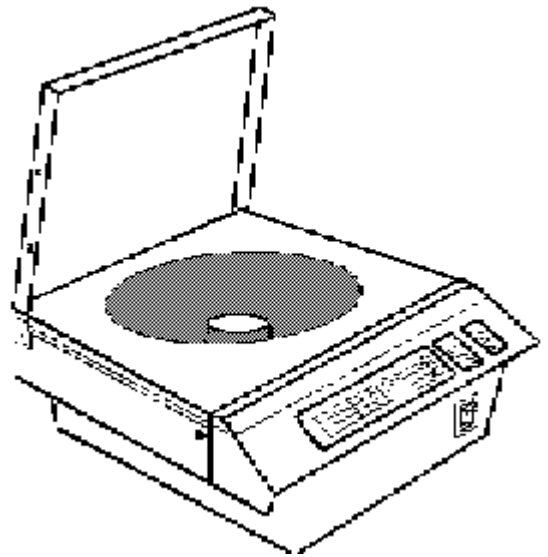

8.3.4 SEALED HEAD ASSEMBLY

FREQUENCY

Daily and immediately after any serious spillage.

STERILIZE

Autoclave all the Sealed Head, its components and accessories at 121°C (250°F) for 15 minutes. Unlock the lid so that steam can fully penetrate the interior.

Alternatively, submerge the Sealed Head and its components and accessories in a 10% solution of commercial bleach in water for not less than one hour.

CLEAN: After sterilization wash the Sealed Head and its components and accessories in warm soapy water. Dry in an oven at a temperature not exceeding 65°C (149°F).

8.3.4

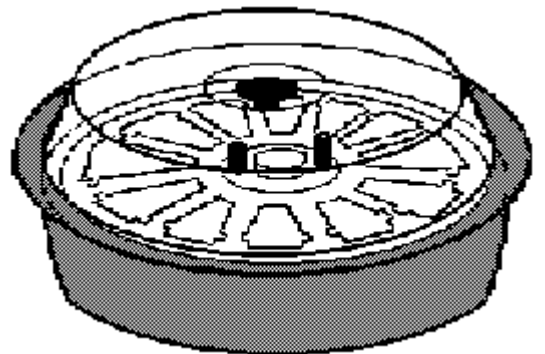

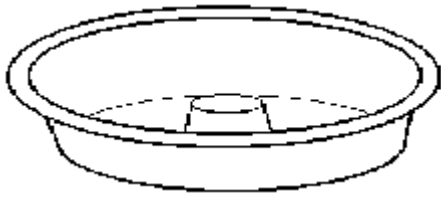

8.3.5

8.3.5 SEALED HEAD BASE

FREQUENCY

Daily and immediately after any serious spillage.

STERILIZE

Autoclave at 121°C (250°F) for 15 minutes.

Alternatively, submerge in a 10% solution of commercial bleach in water for not less than one hour.

CLEAN: After sterilization wash the Sealed Head base in warm soapy water. Rinse in clear water, then dry.

AVOID the use of hard brushes.

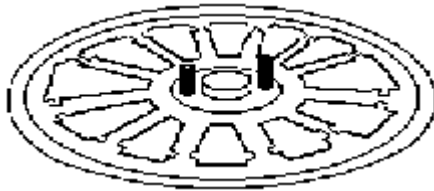

8.3.6

8.3.6 SLIDE CLIP SUPPORT PLATE

Note

- 1 Undo and remove the two thumb screws then lift up and remove the Support Plate to gain access to its underside.

FREQUENCY

Daily.

STERILIZE

Autoclave at 121°C (250°F) for 15 minutes.

Alternatively, submerge in a 10% solution of commercial bleach in water for not less than one hour.

CLEAN: After sterilization wash the Slide Clip Support Plate in warm soapy water. Rinse in clear water, then dry.

AVOID the use of hard brushes.

8.3.7 SEALED HEAD LID

FREQUENCY

Daily and immediately after any serious spillage.

Weekly Remove the silicone rubber seal from around the rim of the lid and clean the surface of the lid. Replace the seal.

Monthly grease the locking ball bearing assembly.

Annually fit a replacement seal.

STERILIZE

Autoclave at 121°C (250°F) for 15 minutes.

Alternatively, submerge in a 10% solution of commercial bleach in water for not less than one hour.

CLEAN: After sterilization wash the Sealed Head lid in warm soapy water. Rinse in clear water, then dry.

AVOID the use of hard brushes.
abrasive powders.
Xylene, toluene or similar solvents.

8.3.7

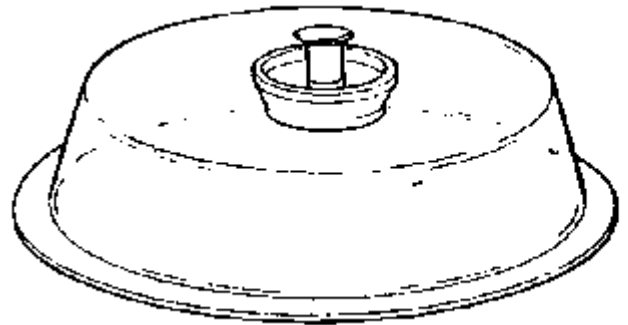

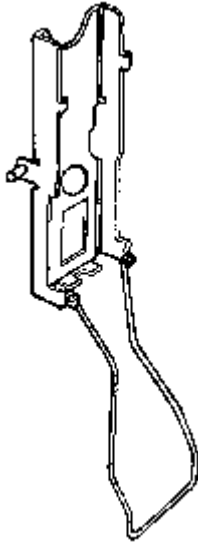

8.3.8

8.3.8 CYTOCLIP™ SLIDE CLIP

Note

- 1 For Slide Clip, Part No 5991052M, snap open the spring; for spring loaded Slide Clip, Part No 5991017M, turn the pressure release screw fully counter clockwise to release the spring pressure.

FREQUENCY

Daily

STERILIZE

Autoclave at 121°C (250°F) for 15 minutes.

Alternatively, submerge in a 10% solution of commercial bleach in water for not less than one hour.

CLEAN: Rinse in clear water and hot air dry before use.

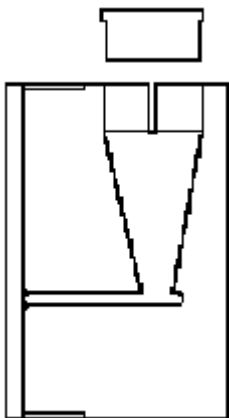

8.3.9

8.3.9 REUSABLE SAMPLE CHAMBER

FREQUENCY

After use.

STERILIZE

Autoclave at 121°C (250°F) for 15 minutes.

Alternatively, submerge in a 10% solution of commercial bleach in water for not less than one hour.

CLEAN: Use a cotton tipped applicator swab and hot soapy water to clean the outlet port and funnel. Rinse in clean water then dry.

AVOID Immersion in disinfectant for more than 5 minutes.

Phenolic disinfectants.

Autoclaving the plastic cap.

The use of a wire brush.

Note

- 1 *Discoloration due to repeated autoclaving does not adversely affect the performance of the Sample Chamber.*

8.3.10 FILTER CARDS

Note

- 1 *The Filter Cards are disposable, single-use items that are designed to be discarded immediately after use. However, they must be rendered safe by sterilization before being consigned for disposal.*

8.3.10

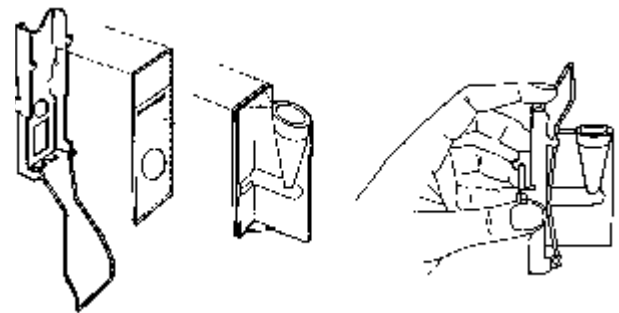

FREQUENCY

After use.

STERILIZE

Discard into a phenolic disinfectant,
or,

Autoclave at 121°C (250°F) for 15
minutes.

Alternatively, submerge in a 10%
solution of commercial bleach in
water for not less than one hour.

DISPOSE

in the approved manner according to
local procedures.

8.4 SEAL REPLACEMENT

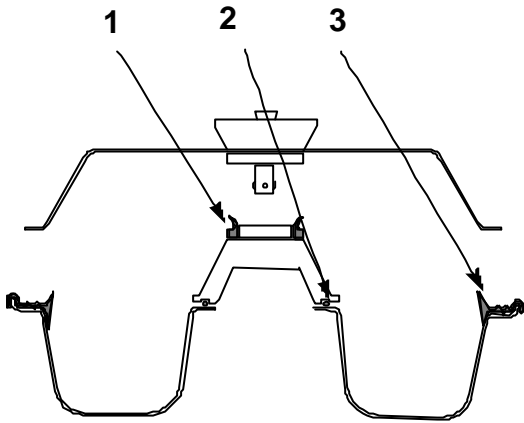

8.4.1

8.4.1 Three flexible seals are fitted in the Sealed Head - the Cone Seal (1), an 'O' Ring Seal (2), and a Lid Seal (3).

8.4.2 All the seals are designed to withstand normal cleaning and sterilization as part of the routine maintenance of the Sealed Head. However, the seals eventually become worn, stretched, or degraded by the action of chemicals over a period of time and should be replaced annually.

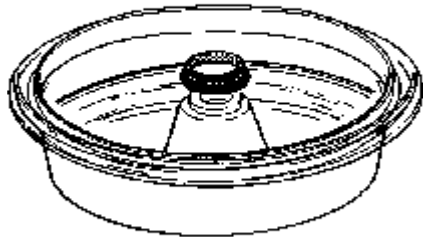

8.4.3

8.4.3 **To Remove the Sealed Head Cone Seal (1)**, simply pull the old seal off the cone.

8.4.4 **To Fit the Sealed Head Cone Seal (1)**. Stretch the replacement Cone Seal (Part No P07431), with the thin lip uppermost, onto the collar of the centre cone.

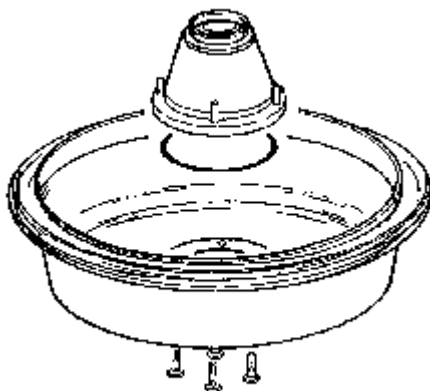

8.4.5

8.4.5 **To Remove the Sealed Head 'O' Ring Seal (2)**, Use a screwdriver to undo the four screws that secure the cone to the base, then remove the cone and lift the 'O' ring from its groove.

8.4.6 **To Fit the Sealed Head 'O' Ring Seal (2).** Fit a replacement 'O' Ring Seal (Part No P07525) in its groove in the cone. Make sure that the 'O' ring fits correctly in its groove then fit the cone to the base. Fit, then tighten, the four screws.

8.4.7 **To Remove the Sealed Head Lid Seal (3),** pull the old seal off the rim of the bowl.

8.4.7

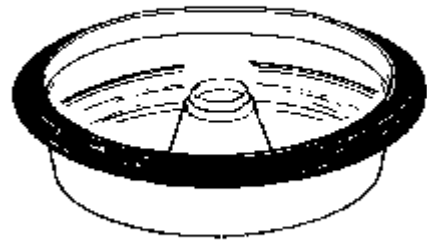

8.4.8 **To Fit the Sealed Head Lid Seal (3).** Place the replacement Lid Seal (Part No P07516) on the rim of the bowl then push the lip of the seal over the vertical edge at the periphery of the bowl. Make sure that the seal fits uniformly around the rim.

8.4.8

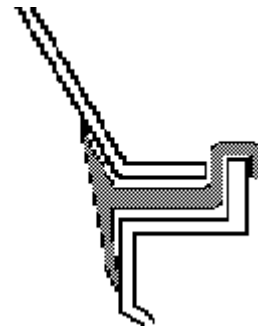

TROUBLE SHOOTING

9.1 GENERAL

9.1.1 Correct service and maintenance is essential for the long term serviceability of precision engineered products such as Cytospin® 3. We strongly recommend that a Thermo Shandon Service Contract is used to ensure future reliability, and consistency of performance.

9.1.2 Table 1 shows remedial action to be taken if Cytospin® fails to operate.

9.1.3 Tables 2 to 5 relate to processing problems and suggested solutions with respect to the preparation of cells by cytocentrifugation.

TABLE 1 - EQUIPMENT STATUS CHECKS

SYMPTOM	CAUSE	REMEDY
Displays not lit on control panel	<ol style="list-style-type: none"> 1 No Power Supply. 2 Mains fuse blown. 3 Internal Instrument Fuse blown. 	<ol style="list-style-type: none"> 1 Check the Mains supply. 2 Replace the mains fuse. 3 Replace the instrument fuse (Note only a technically competent person should replace fuses).
Programs do not run.	<ol style="list-style-type: none"> 1 Stopped at instrument. 2 Incorrect programming. 	<ol style="list-style-type: none"> 1 Press [START]. 2 Check ranges 200 -2000 r.p.m. 1 - 99 minutes.
BAL alarm lit.	<ol style="list-style-type: none"> 1 Load out of balance. 	<ol style="list-style-type: none"> 1 Switch OFF then ON again. 2 Check sample carrier distribution. 3 Check Sealed Head for damage.
! alarm lit.	<ol style="list-style-type: none"> 1 Overspeed. 	<ol style="list-style-type: none"> 1 Switch OFF then ON again (see 7.3.3). 2 Check that the Sealed Head is installed correctly. 3 Contact Thermo Shandon Service if problem persists.
BAL and ! alarms flash together.	<ol style="list-style-type: none"> 1 Cytospin travelling. 	<ol style="list-style-type: none"> 1 Check load distribution. Reset alarm. (see 7.3.2).
LID LOCK lit	<ol style="list-style-type: none"> 1 Lid sequence interlock. 	<ol style="list-style-type: none"> 1 Open and close lid. (see 7.3.4).

TABLE 2 QUALITATIVELY ABERRANT CYTOCENTRIFUGATION RESULTS

PROBLEM	CAUSE	SOLUTION
BEFORE CYTOCENTRIFUGATION		
Poorly preserved cells.	<ol style="list-style-type: none"> 1 Preserved poorly in vivo. 2 Lengthy delays between collection and preparation. 3 Cells suspended in normal saline. 	<ol style="list-style-type: none"> 1 Request repeat specimen. 2 Minimize delays (e.g. less than 4 hr. Refrigerate if longer). 3 Use balanced electrolyte solution.
Cells small in diameter; optically dense.	<ol style="list-style-type: none"> 1 Cells collected in high proportion of strong alcohol. 2 Alcohol added to sample chamber begins to rise through the cell suspension and causes cell shrinkage when it mixes. 	<ol style="list-style-type: none"> 1 Collect unfixed fresh specimens, or mix with equal volume of 50% ethanol. 2 Add less alcohol; add alcohol carefully.
RBCs hemolysed; ghosts remain.	<ol style="list-style-type: none"> 1 Alcohol was mixed with cell suspension. 	<ol style="list-style-type: none"> 1 Add alcohol carefully to sample chamber.
DURING CYTOCENTRIFUGATION		
Cells air dried.	<ol style="list-style-type: none"> 1 Cell suspension medium absorbed completely by filter card. 	<ol style="list-style-type: none"> 1 Fill cylindrical sample chamber before cytocentrifugation; use Cytospin® Collection Fluid; reduce the cytocentrifugation time and / or speed.
Cells air dried around periphery of collection area.	<ol style="list-style-type: none"> 1 Cell suspension medium almost completely absorbed by filter card. 	<ol style="list-style-type: none"> 1 Increase specimen volume up to 0.5ml; use Cytospin® Collection Fluid; reduce cytocentrifugation time and/or speed.
AFTER CYTOCENTRIFUGATION		
Cells air dried.	<ol style="list-style-type: none"> 1 Film of liquid over the cells allowed to evaporate during brief interval between unloading and immersion in alcohol. 	<ol style="list-style-type: none"> 1 Move quickly to avoid evaporation of protective film from over the cells.
Cells air dried around periphery of collection area.	<ol style="list-style-type: none"> 1 Film of liquid is thinnest at its edges and evaporates before the thick central area. 	<ol style="list-style-type: none"> 1 Immerse cells in alcohol before air drying progresses on to periphery of cell area.
Disrupted air dried pale cells, resemble 'basket cells' of hematology.	<ol style="list-style-type: none"> 1 Fragile cells air dried and exaggerated by centrifugal force. 	<ol style="list-style-type: none"> 1 Request repeat specimen. Do not allow to air dry.

TABLE 3 QUANTITAVELY ABERRANT CYTOCENTRIFUGATION RESULTS
Number of Cells

PROBLEM	CAUSE	SOLUTION
BEFORE CYTOCENTRIFUGATION		
No cells	1 Exit port blocked by filter card.	1 Seat filter card to foot of side clip.
Abnormal cells in specimen but not on cytocentrifuged preparations.	1 Abnormal cells, usually larger and heavier than normal cells, sediment to bottom of concentrate. May be missed if not resuspended completely following conventional centrifugation.	1 Apply centrifuge tube with cell concentrate and several ml of balanced electrolyte solution to vortex mixer and completely resuspend cells.
Too few cells.	<p>1 Too few cells in raw specimen.</p> <p>2 Too few cells added to sample chamber.</p> <p>3 Sparsely populated specimen may have filled the cylindrical and conical portions of the sample chamber.</p> <p>4 Partially filled cone raised level of specimen in cylinder to filter card level where cells can be absorbed.</p> <p>5 Cells crowded out by precipitated hyaluronic acid in joint fluid.</p> <p>6 Cells crowded out by precipitated phosphate salts in urine.</p> <p>7 Cells crowded out by erythrocytes.</p> <p>8 Slide is between exit port and filter card .</p>	<p>1 Enrich by conventional centrifugation. Resuspend cells in 1-2ml balanced electrolyte solution. Combine contents of multiple centrifuge tubes of same specimen when possible. microscopically examine drop of resuspended cell concentrate; Base sample size on cell count. Request repeat specimen; suggest ways to increase cellular harvest.</p> <p>2 Base sample size on cell count of drop of resuspended cell concentrate.</p> <p>3 Enrich specimen as described above.</p> <p>4 Do not allow distal boundary of specimen to touch filter card before cytocentrifugation.</p> <p>5 Dissolve hyaluronic acid precipitate with pinch of hyaluronidase.</p> <p>6 Mix several drops of glacial acetic acid to lower the pH and redissolve the alkaline pH dependant precipitated phosphate salts.</p> <p>7 Saponize specimen.</p> <p>8 Load in correct sequence; sample chamber filter card side.</p>
Too many cells.	1 Too much densely populated cell suspension added to sample chamber.	<p>1 Microscopically examine drop of resuspended cell concentrate; dilute up to 10x if necessary; base sample size on cell count or derive it from hematological counting chamber.</p> <p>2 Do not rely on visual estimates of specimen appearance.</p>

**TABLE 3 QUANTITAVELY ABERRANT CYTOCENTRIFUGATION RESULTS
Number of Cells (Continuation)**

PROBLEM	CAUSE	SOLUTION
DURING CYTOCENTRIFUGATION		
Too few cells.	1 Exit port blocked by misaligned filter card.	1 Check alignment as seen through window from back of slide clip; seat filter card.
	2 Cells lost through gap between exit port and filter card.	1 Unlikely; though check assembled unit for alignment.
AFTER CYTOCENTRIFUGATION		
Too few cells.	1 Suspension medium absorbed incompletely as a result of filter card becoming clogged by debris in previously non-centrifuged specimen and/or pores collapse from too much pressure from spring or excessive centrifugal force	1 Centrifuge specimen at 3000 r.p.m. for 10 min. to sediment cells and leave debris in suspension to be discarded with supernatant. Do not wet blotter before cytocentrifugation. Cytocentrifuge specimen at 1000 r.p.m. for 6-10 min.
	2 Unabsorbed suspension medium can induce cell wash-off.	2 Unload horizontal sample chamber, cell side up. Allow blotter to absorb excess liquid. Lift chamber and blotter away from slide. Lay slide flat until a thin film remains; immerse in fixative.

TABLE 4 UNUSUAL PATTERN OF CELL POPULATION DISTRIBUTION

PROBLEM	CAUSE	SOLUTION
BEFORE CYTOCENTRIFUGATION		
Crescent shaped distribution.	1 Cylinder filled incompletely. 2 Cells settle in cylinder if prolonged delay before cytocentrifugation.	1 Fill cylinder completely. 2 Rapidly load sample chambers and begin cytocentrifugation immediately.
Display area displaced from label end.	1 Slide not seated to foot of slide clip.	1 Seat slide to foot of slide clip.
Display area displaced towards label end.	1 Slide placed in slide clip label end down.	1 Insert slide label end up.
Cells on underside of slide	1 Slides loaded backwards.	1 Orient slide with label facing exit port.

TABLE 4 UNUSUAL PATTERN OF CELL POPULATION DISTRIBUTION (Continuation)

PROBLEM	CAUSE	SOLUTION
AFTER CYTOCENTRIFUGATION		
Cell population streams towards label end or to opposite end.	1 Thinly layered cells too wet and are either pushed up the slide upon immersion in alcohol, or slide down the slide following immersion.	1 Let the suspension medium evaporate almost completely.
Circular band of cells, acellular centre, 'Bull's Eye' distribution.	1 Thickly layered cells, margins nearly dry but centre remains very wet and promotes cell wash-off.	1 Add less cell suspension.

TABLE 5 SUMMARY

To predictably produce cytocentrifuged preparations that exhibit within a 32mm² circle a representative sample of randomly distributed, uncrowded, monolayered, flattened cells that are well preserved and displayed, the materials and methods that follow are recommended:

BEFORE CYTOCENTRIFUGATION	
DO	DO NOT
<ol style="list-style-type: none"> 1 Use Unfixed fresh cell suspension. 2 Saponinize bloody cell suspensions. 3 Equalize differences in cell suspensions 4 Control the number of cells. 5 Use clean Micro slides. 6 Use balanced electrolyte solution. 7 Keep cell suspension from the filter card. 8 Fill sample chambers with similar volumes. 	<ol style="list-style-type: none"> 1 <i>Use cell suspensions collected in alcohol.</i> 2 <i>Use bloody cell suspensions.</i> 3 <i>Cytospin un-processed cell suspensions.</i> 4 <i>Estimate number of cells.</i> 5 <i>Use frosted or albumenized micro slides.</i> 6 <i>Use normal saline.</i> 7 <i>Let the cell suspension touch the filter card.</i> 8 <i>Use significantly different volumes.</i>
DURING CYTOCENTRIFUGATION	
DO	DO NOT
<ol style="list-style-type: none"> 1 Centrifuge specimen at 1000 r.p.m. 2 Centrifuge for 3 - 4 minutes until nearly dry. 	<ol style="list-style-type: none"> 1 <i>Centrifuge too rapidly.</i> 2 <i>Centrifuge too briefly, or for too long.</i>
AFTER CYTOCENTRIFUGATION	
DO	DO NOT
<ol style="list-style-type: none"> 1 Keep the cells slightly wet. 2 Immerse immediately the cytological preparation in 95% ethanol for ethanol preps. 3 Allow the cellular monolayer to air-dry before staining when using Cytospin® Collection Fluid 	<ol style="list-style-type: none"> 1 <i>Allow the cells to air dry unless intended.</i> 2 <i>Let too much liquid remain on the cells.</i> 3 <i>Immerse in 95% ethanol until the cell monolayers prepared with Cytospin Collection Fluid have dried sufficiently - unless otherwise specified.</i>

SPECIFICATION, ACCESSORIES AND CONSUMABLES

10.1 SPECIFICATION

10.1.1	<u>Physical</u>	Height	215mm	(8 1/2 in)
		Height - Clearance	560mm	(22 in)
		Width	385mm	(15 1/4 in)
		Width - Clearance	405mm	(16 in)
		Depth	495mm	(19.5 in)
		Depth - Clearance	556mm	(21.7/8 in)
		Weight (Kg)	18 Kg	(39 3/4 lb)
		Mounting	Bench - 4 fixed feet	
		10.1.2	<u>Electrical</u>	Power
Voltages - (factory set)	110 - 120 V ~ 220 - 240 V ~			
Frequency	50/60 Hz			
Fuse Type:				
Mains Plug	5 Amp			(UK instruments only)
110 - 120 V	T2.0 Amp			Slow Blow
220 - 240 V	T0.8 Amp	Slow Blow		
10.1.3	<u>Switch Convention</u>	<p>I = Power On O = Power Off</p>		
10.1.4	<u>Indicator Panel</u>	<i>All Models</i>	Membrane type, touch sensitive switches and LED displays.	
10.1.5	<u>Capacities</u>	<i>All Models</i>	Sample Chamber	0.1 - 0.5 ml
			Megafunnel	6.0 ml.
Note				
1 This instrument is intended for use with body fluids. It is not necessary to de-rate the instrument for different densities of sample provided that the instrument is used for its intended purpose.				
10.1.6	<u>Environment</u>	General	Indoor use only.	
		Temperature	+5°C to + 40°C	
		Humidity	80% max for temperatures < 31°C	
			50% max for temperatures 31°C to 40°C (Non condensing environment)	
		Altitude	Up to 2000m	
		Pollution Degree	2 (as defined in IEC1010)	
Installation Category	II (as defined in IEC1010)			
10.1.7	<u>Operating Speed Range</u>	200 - 2000 r.p.m.		
10.1.8	<u>Safety Interlocks</u>	<p>Safety Cover sequence interlock. Safety Cover locked closed while centrifuging. Controls inoperable while the rotor is turning. Drive motor cut off if instrument moves.</p>		
10.1.9	<u>Noise</u>	The sound pressure level at workstations does not exceed 70 dB.		

10.2 ACCESSORIES - (Sold Separately)

DESCRIPTION		CATALOGUE NUMBER	
		International	US
CYTOSPIN® Unit	- each	74000001	7400002
Packing and Carton	- each		1612084
Sealed Head (Slide Clips not supplied)	- each	59910018	5991018
Stainless steel Cytoclip™ Slide Clip	- 6 pack	59910052	
Stainless steel Cytoclip™ Slide Clip	- 2 x 6 pack		5991052
Re-usable (Autoclavable) Sample Chamber	- each	5991002	
Operator Guide handbook	- each	74010121	7401121
Silicone Rubber Head Seals-	- 1 x 3 pack	59910019	5991019
Cytofunnel® disposable double white Sample Chambers with caps	- box 25	59910039	5991039
Cytofunnel® disposable single white Sample Chambers with caps	- box 50	59910040	5991040
Cytoslide™ Regular Microscope slides, single circle, frosted end	- box 100	59910051	5991051
Cytoslide™, double circle, Sample	- 2 x box 25		5991058
Consumables Catalog	- each		31202
Sample pack containing			1950425
	6 x Collection Fluid (60ml cup)		
	1 x Collection Fluid (500ml bottle)		
	1 x Cell Fixx™ Spray (50ml)		
Warranty Card	- each		1000291
Cytospin® Wall Chart			
Extended Service Contract Offer	- each		1001436
Delivery Questionnaire	- each		1001437

10.3 CONSUMABLES - (Sold Separately)

DESCRIPTION		CATALOGUE NUMBER	
		International	US
Thick White filter cards for volumes of 0.5 ml	- box 200	59910022	5991022
Brown filter cards	- box 200	59910023	
TPX Sample Chamber	- each	59910021	
Closure Caps	- 12 pack	59910025	5991025
Cytofunnel® disposable single white Sample Chambers with caps	- box 50	59910040	5991040
Cytofunnel® single Sample Chambers (white, bulk pack)	- box 500	1102548	1102548
Cytofunnel® disposable double white Sample Chambers with caps	- box 25	59910039	5991039
Cytofunnel® single Sample Chambers (brown)	- box 50	59910043	
Cytofunnel® double Sample Chambers (white, bulk pack)	- box 500	1102547	1102547
Cytofunnel® single Sample Chambers, Sterile	- box 25	5991044	5991044
Cytofunnel® double Sample Chambers, Sterile	- box 50	5991042	5991042
Megafunnel large volume Sample Chamber (6.0 ml capacity)	- box 25	5991028	5991028
Cytoslide™ Regular Microscope slides, single circle, frosted end	- box 100	59910051	5991051
Cytoslide™ Coated Microscope slides, single circle, frosted end	- box 100	59910056	5991056
Cytoslide™ Regular Microscope slides, double circle, frosted end	- box 100	59910054	5991054
Cytoslide™ Coated Microscope slides, double circle, frosted end	- box 100	59910055	5991055
Cytoslide™ Black Mask Microscope slide for immunofluorescence	- box 100	59910057	5991057
Regular Microscope slides, Plain, (sold only by gross)(USA)	- box 72		1450
Regular Microscope slides, Frosted End, (sold only by gross)(USA)	- box 72		146012
Regular Microscope slides, Superfrost®, (sold only by gross)(USA)	- box 72		147019

10.3 - Continuation **CONSUMABLES (Sold Separately)**

DESCRIPTION		CATALOGUE NUMBER	
		International	US
Cytospin® Collection Fluid in 4 litre container with pump	- each	67680001	9990301
Cytospin® Collection Fluid in 120 ml cups 1/2 filled	- case 50	67680017	9990321
Cytospin® Collection Fluid in 500 ml bottles (USA)	- 2 pack		9990315
Cytospin® Collection Fluid in 10 litre bottles	- 2 pack	67680016	9990310
Cell-Fixx™ spray fixative in 50 ml bottle(USA)	- each		9990325
Cell-Fixx™ spray fixative in 50 ml bottles	- 6 pack	99900326	9990326
Mucolexx Transport Medium Fluid in 500ml bottles	- 4 pack	9990370	9990370
Cytoblock™ Cell Block Preparation System	- each	74010150	7401050

10.4

WARRANTY STATEMENT

We are proud of our quality and reliability, and of our after-sales service. We continuously strive to improve our service to our customers.

Please ask your distributor or representative about Service Contracts which can keep your purchase in peak condition for many years to come.

Warranty provisions necessarily vary to comply with differences in national and regional legislation, and you can find details in your delivery documents or from your dealer or representative.

Declaration of Conformity

Manufacturer's Name: Thermo Shandon Limited,
Manufacturer's Address: 93 - 96 Chadwick Road, Runcorn,
Cheshire, WA7 1PR
ENGLAND

Product Description: Cell Preparation System
Product Designation: **Cytospin[®] 3**
Year of Marking (CE): 1996

This product conforms with the essential requirements of the following directives;

EMC Directive	89/336/EEC (as amended by 92/31/EEC & 93/68/EEC).
Low Voltage Directive	73/23/EEC (as amended by 93/68/EEC).

This product complies with the following International Standards:

EMC:	EN55022 class B
Safety:	EN50082 - 1
	IEC1010-2-020
	CAN/CSA Standard C22.2: 1010-1-92
	UL Standard: 3101-1

Issued by: Mr R.Russell-Smith
Director of Quality
Thermo Shandon Limited

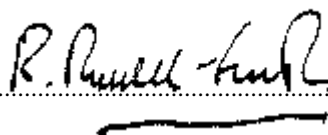
.....

INDEX

TOPIC	SECTION	PAGE
A	Acceleration ...To Set	5.2.115.3
	Accessories (Sold Separately)	10.210.2
	Alarms.5.3.. .5.3	
	Audible Tones	5.55.4
	BAL	5.3.15.3
	'!'	5.3.25.3
	Lid Lock.	5.3.35.4
	BAL and !	5.3.45.4
B	BAL	5.3.15.3
	BAL and !	5.3.45.4
	Bio Hazard Clearance Certificate	Appendix 2
C	Cancel	5.2.55.3
	Certificate of Conformity	11.211.2
	Construction ...2.2 .. .2.2	
	Consumables (Sold Separately)	10.210.2
	CLEANING AND MAINTENANCE	8.1
	Routine Maintenance	8.38.2
	Bowl Liner	8.3.38.3
	Cytoclip™ Slide Clip.	8.3.88.6
	Front Panel	8.3.1.8.2
	Reusable Sample Chamber	8.3.98.6
	Safety Cover	8.3.28.2
	Sealed Head	8.3.48.2
	Sealed Head - Base	8.3.58.4
	Sealed Head - Lid	8.3.78.5
	Slide Clip Support Plate ...	8.3.68.4
	CONTENTS	2
	CONTROL PANEL	5.1
	AUDIBLE TONES	5.55.4
	GENERAL	5.15.1
	PROGRAM MODE SECTION	5.25.2
	CONTROL SECTION	5.45.4
	ALARM SECTION	5.35.3

Continued

Continuation

TOPIC	SECTION	PAGE
Cone Seal,	To Fit the Sealed Head ~ 8.4.4	8.8
	To Remove the Sealed Head ~ 8.4.3	8.8
Lid Seal,	To Fit the Sealed Head ~. 8.4.8	8.9
	To Remove the Sealed Head ~ 8.4.7	8.9
'O' Ring Seal	To Fit the Sealed Head ~. 8.4.6	8.9
	To Remove the Sealed Head ~ 8.4.5	8.8
Cytoclip	To Load the ~ 4.1.3	4.1
	To Unload the 4.1.4.	4.2
Cytofunnels	Disposable 4.1.5	4.2
Cytospin Collection Fluid	10.2.	10.2
D	DESCRIPTION	2.1
	Operating Principles 2.1	2.1
	Construction 2.2	2.2
Disinfect	8.1.1 (ii)	8.1
Disposable Cytofunnels	4.1.5	4.2
Duration To Set	5.2.3	5.2
E	Emergency Release 3.1.14	3.4
End of Cycle	5.5.2	5.4
Equipment Status Checks	Table 1	9.1
F	Filter Cards 8.3.10	8.7
Front Panel	5.1	5.1
G	'g' Forces 7.1.6	7.2
H		
I	INDEX	12.1
	INSTALLATION INSTRUCTIONS	3.1
	Procedure 3.1	3.1
Introduction	1.1	1.1

Continued

Continuation

	TOPIC	SECTION	PAGE
J			
K			
L	LID LOCK	5.3.3	5.3.4
	Loading	listed under subject.	
M	MAINTENANCE, CLEANING AND ~		8.1
	General	8.1	8.1
	Recommended Materials	8.2	8.2
	Routine Maintenance	8.2	8.1
	Bowl Liner	8.3.3	8.3
	Cytoclip™ Slide Clip	8.3.8	8.6
	Front Panel	8.3.1	8.2
	Reusable Sample Chamber	8.3.9	8.6
	Safety Cover	8.3.2	8.2
	Sealed Head	8.3.4	8.2
	Sealed Head - Base	8.3.5	8.4
	Sealed Head - Lid	8.3.7	8.5
	Slide Clip Support Plate	8.3.6	8.4
	Methodology Guidelines Appendix 1		
N			
O	Open Lid	5.4.1	5.4
	OPERATING		7.1
	Introduction .7.1	7.1	7.1
	Methodology Guidelines	7.2	7.2
	To Reset Cytospin®	7.3	7.2
	BAL	7.3.1	7.2
	BAL and '!'	7.3.2	7.3
	'!'	7.3.3	7.3
	LID LOCK	7.3.4	7.4
	Operating Principles	2.1	2.1
P	Procedure	3.1	3.1
	PROGRAMMING		6.1
	To Enter a Program	6.1	6.1
	To Start a Program	6.2	6.2
	To Save a Program	6.3	6.2

Continued

Continuation

TOPIC	SECTION	PAGE
Programming (Continuation)		
To Run a Program	6.4	6.2
To View a Program in Memory	6.5	6.2
To Repeat a Program	6.6	6.3
To Stop a Program	6.8	6.3
Using Cancel	6.7	6.3

Q

R

Recommended Materials	8.2	8.2
Reset, To ~ Cytospin® 7.3	7.2	
.....BAL	7.3.1	7.2
.....BAL and '!'	7.3.2	7.3
.....'!'	7.3.3	7.3
.....LID LOCK	7.3.4	7.4
Routine Maintenance	8.2	8.1
Bowl Liner	8.3.3	8.3
Cytoclip™ Slide Clip	8.3.8	8.6
Front Panel	8.3.1	8.2
Reusable Sample Chamber	8.3.9	8.6
Safety Cover	8.3.2	8.2
Sealed Head	8.3.4	8.2
Sealed Head - Base	8.3.5	8.4
Sealed Head - Lid	8.3.7	8.5
Slide Clip Support Plate	8.3.6	8.4

S

Safety	1.3	1.1
Save	5.2.8	5.3
Sealed Head		
- To Close the ~	4.1.2	4.1
- To Install the ~	4.1.8	4.2
- To Load the ~	4.1.6	4.2
- To Open the ~	4.1.1	4.1
- To Remove the ~	4.1.9	4.2
Set Acceleration	5.2.11	5.3
Set Speed.	5.2.1	5.2
Set Time	5.2.2	5.2

Continued

Continuation

TOPIC	SECTION	PAGE
SETTING UP		4.1
	Disposable Cytofunnels . . . 4.1.5	4.2
	To Open the Sealed Head . 4.1.1..	4.1
	To Close the Sealed Head . 4.1.2	4.1
	To Load the Sealed Head . . 4.1.6	4.2
	To Load the.Cytoclip 4.1.3	4.1
	To Unload the Cytoclip . . . 4.1.4	4.2
	To Install the Sealed Head . 4.1.8	4.2
	To Remove the Sealed Head4.1.9	4.2
SPECIFICATION, ACCESSORIES AND CONSUMABLES		11.1
Start5.4.2	5.4
Stop5.4.3	5.4
T	TROUBLE SHOOTING	10.1
U		
V	View	6.56.2
W	Warning Notices1.41.1
	Warranty Statement11.1
	WELCOME1.1
X		
Y		
Z		

APPENDIX 1 - METHODOLOGY GUIDELINES

1 INTRODUCTION

Cytospin is a special purpose instrument designed to deposit cells on to glass slides. The instrument produces monolayer cell deposition in a defined area of the slide, using centrifugal force. For most cytological specimens the Cytospin offers significant advantages in specimen retention, preparation, and standardisation, and ease of specimen evaluation.

Cytological specimens may also be deposited on to slides by techniques such as direct smears or by filter techniques. While useful with some specimens, both direct smears and filter techniques have significant disadvantages when compared with Cytospin preparations.

Direct smears consistently produce preparations of varying thickness from end to end of the smear. In addition, severe mechanical damage may result to many cells within the preparation. There is also a likelihood of selective cell distribution within the smear. Cells of different sizes will be deposited in different areas of the smear.

Filter preparations, while excellent for cell retention, are technically demanding and time consuming. In addition, filter preparations rarely yield slides which can be evaluated easily. The cells are seldom in the same plane as the focus within the microscope, and it is extremely difficult to obtain well stained cells without also staining the filter. For those filter techniques which dissolve the filter, there is a significant risk of cell loss, in addition to the difficulty and hazards of using a volatile and dangerous solvent.

Cytospin preparations effectively circumvent these difficulties, and consistently produce uniform preparations of cells which are easily stained and evaluated. In addition, the construction of the Cytospin ensures maximum containment of potentially hazardous specimens, thereby reducing the risk to laboratory personnel.

Specimens from body fluids and all body sites can be used for Cytospin preparations. The primary requirements are that the specimen be a cell suspension, preferably of single cells, and that the

cells are fresh and intact enough to yield diagnostic information. With proper application of the general principles of Cytospin operation, consistent preparations of well preserved cell monolayers should result.

2 GENERAL LABORATORY CONSIDERATIONS

The Cytospin is designed to provide maximum protection to the operator by completely containing potentially hazardous specimens. However, Cytospin cannot protect the operator during the various steps required to process a specimen prior to using the Cytospin. Good laboratory practice requires the use of a biological safety cabinet for all manipulators of cytological specimens. This includes both the loading and unloading steps for the Cytospin. Once the specimen is loaded into the Cytospin sealed head, and the lid is sealed in place, the sealed head may then be taken outside the biological safety cabinet for spinning in the Cytospin. After the Cytospin has stopped, the sealed head should be returned to the biological safety cabinet prior to being opened.

Due to the potentially infectious nature of the specimens which may be processed in the Cytospin, the laboratory must establish procedures to ensure that the instrument is routinely disinfected. Suggested methods for cleaning and disinfecting of the Cytospin and accessories will be found in the Cleaning and Maintenance section of the Operator Guide.

As with all clinical specimens, it is extremely important to maintain specimen identification. For the Cytospin, this means that the slides on to which a specimen will be deposited must be adequately labelled with the appropriate specimen identification. The method of labelling must take into account the subsequent procedures which will be used. In general, it would be expected that the label may be subjected to fixation steps and staining procedures. Obviously, a paper label would be inappropriate. Pencil identification on frosted-end glass slides is the most common approach to specimen identification.

APPENDIX 1 - METHODOLOGY GUIDELINES

The laboratory must also ensure that adequate labelling is maintained for all containers or devices to which the specimen is transferred. In use of the Cytospin, this may include one or more centrifugation steps, conducted in a standard laboratory centrifuge. Each new container to which the specimen is transferred must be appropriately labelled. In addition, the laboratory must ensure containment of the specimen to eliminate potential hazards to the laboratory personnel. Since most centrifuges do not provide aerosol containment during operation, any intermediate centrifugation steps should be conducted in a biological safety cabinet. At the conclusion of specimen preparation, all intermediate containers, pipettes, etc., should be disposed of in an appropriate biohazard container.

3 SPECIMEN PREPARATION

a Initial Examination

Cytological examination always begins with a macroscopic examination of the specimen at the time it is submitted to the laboratory. This is a crucial examination, as it provides information which will be used to select processing protocol. The macroscopic examination is most useful in the hands of an experienced technologist. Prior experience with a particular specimen is invaluable in recognising whether a given sample is normal or highly suspect, and whether the specimen will be adequate for cytological examination. However, it is usually impossible to determine if a given sample contains abnormal cells from the macroscopic examination only. A specimen which should normally be clear should not be assumed to be abnormal simply because it is bloody on arrival in the laboratory. Any number of circumstances may produce a different appearance in a specimen during the collection process.

The macroscopic examination cannot be used as a definitive test of the specimen. It does serve to support the eventual diagnostic assessment, but more importantly, it provides the information which will allow the technologist to choose a specimen preparation protocol. A complete macroscopic examination may include:

- 1 Record of specimen origin - precise anatomical site.
- 2 Quantity of specimen.
- 3 Specific Gravity (if specimen is **fresh** and unfixed).
- 4 Odor, if present.
- 5 Gross characteristics.

Gross characteristics describe the physical appearance of the specimen. Important parameters are the color of the specimen, its viscosity, and whether the specimen is homogeneous or contains solid tissue fragments.

The gross examination will also determine if the specimen is fresh or if it has been fixed prior to delivery to the laboratory. In general, it is preferable if all cytological samples are submitted to the laboratory in the fresh state. However, in many cases, due to transport distances or time constraints, the specimen will be fixed prior to submission. This must be noted during the gross examination, as fixation may affect several of the parameters recorded during the gross examination. Prior fixation may also constrain the subsequent processing of the specimen. Fixation and its effects will be discussed in a subsequent section of this paper.

b Determination of Cell Number

Successful operation of the Cytospin requires knowledge of the number of cells present in the sample. While the experienced technologist will achieve reasonable results by estimating the cell number, less than optimal preparations sometimes result from such estimates. It is highly recommended that all specimens are examined specifically to determine cell numbers. Visual appearance alone is often confusing, since specimen turbidity may be the result of cell debris, suspended lipids, or other non-cellular materials. In such cases, a direct determination of cell number is necessary to ensure proper Cytospin preparations.

Samples which contain 'average' cells, that is cells with an approximate diameter of ten to twelve microns, produce excellent Cytospin preparations at cell densities of one million cells (1×10^6) per ml.

APPENDIX 1 - METHODOLOGY GUIDELINES

Specimens containing large cells require lower cell concentrations, and specimens with tiny cells, cell organelles, or bacteria, may require higher concentrations. The absolute concentration required will be somewhat dependant on the processing methodology employed. As a general rule, the concentration chosen should be such that the cells within the sample have adequate space to spread into a monolayer on the slide surface, with minimal overlap, or piling up of cells. Ideally, the concentration should be high enough that there is not too much space between cells. Having sufficient concentration of cells speeds up evaluation of the preparation, since little time will be lost in searching for cells to evaluate.

A quick method for approximating the number of cells present in a sample is to place a single drop of the sample on a slide and cover with a 24 x 50 mm coverslip. By lowering the condenser of the microscope, or by closing the microscope condenser diaphragm, the unstained cells can be seen (although detail will not be seen). Using the 10 X objective, scan the field and pick an area that appears about average for the entire slide. The cells will mostly likely not be evenly spread, which is why it is necessary to select an average area. Now switch to the 40 X objective. You may also need to open the diaphragm or raise the condenser slightly.

Count the cells seen in the field. It is not necessary to count every cell - an approximation will do. Refer to the illustration Cells/X 40 Field as a Guideline to the Number of Drops of Cell Suspension/Cytospin Sample Chamber. This count can be used to estimate the number of drops of the cell suspension required for a Cytospin preparation. To determine the number of cells being used, multiply the number of cells counted by 38. Divide the number of cells counted into 60. The quotient equals the number of drops that should be added to the Cytospin sample chamber, though the total volume should not exceed the 0.5 ml capacity of the chamber. This gives the total number of cells applied to the Cytospin funnel for each drop of suspension used. While this technique for estimation of cell number is an approximation only, it does provide an excellent control of Cytospin preparations.

A second method of cell number determination is by manual counting of cells in a hemocytometer. This is

a device which defines a precise volume between a special glass slide and a coverslip. By counting the total number of cells within this volume, the cell concentration within the specimen can be accurately determined. While more accurate than simply using a coverslip on a standard slide, the extra precision of this method is not usually required for successful Cytospin preparations.

A third method for determination of cell number is by use of a cell counter of the electronic volume sensing type (Coulter counter). This instrument can provide a precise evaluation of a cell sample. It does require sufficient amount of sample however, which may not always be available. It is common to determine the cell number of specimens using this instrumentation in the hematology laboratory. Any specimen obtained from the hematology laboratory may include cell number (or concentration) information.

It is important to recognise that samples which are quite concentrated should be handled carefully. For example, if the specimen is so concentrated that only a single drop may be required, the addition of a second drop will double the cell concentration. It is preferable to work with specimens that are dilute enough that five or six drops are required for the preparation. With such a specimen, the addition of one more drop will not be as likely to result in overlapping cells in the final Cytospin preparation.

While it is common to discuss Sample sizes in terms of 'drops', it is important to realise that drop size will be dependant on the type of pipette used to transfer the specimen. As an example, a Falcon 3 ml transfer pipette will dispense approximately 0.5 ml in 15 drops. A six inch glass Pasteur pipette will dispense 0.5 ml in 20 drops. It is advisable to standardise on a single pipette type for all cytological preparations, otherwise 'drops' will be a meaningless measurement.

c Specimen Enrichment

Many cytological specimens arrive in the laboratory as relatively large fluid volumes, many with relatively few cells. Such specimens must obviously be concentrated prior to use of the Cytospin. Such concentration requires the use of a general laboratory centrifuge. The amount of the specimen submitted

APPENDIX 1 - METHODOLOGY GUIDELINES

The large circles represent cells in one drop of cell suspension, either of unprocessed cell specimen or preferably of centrifuged cell concentrate, that have been spread under a 24 x 50 mm cover glass and viewed under a 40X objective. Although drawn smaller than they appear microscopically, the cell and field diameters are proportional to one another at a 50:1 ratio. Simply match the microscopic field with its closest counterpart here and use the number of drops so indicated.

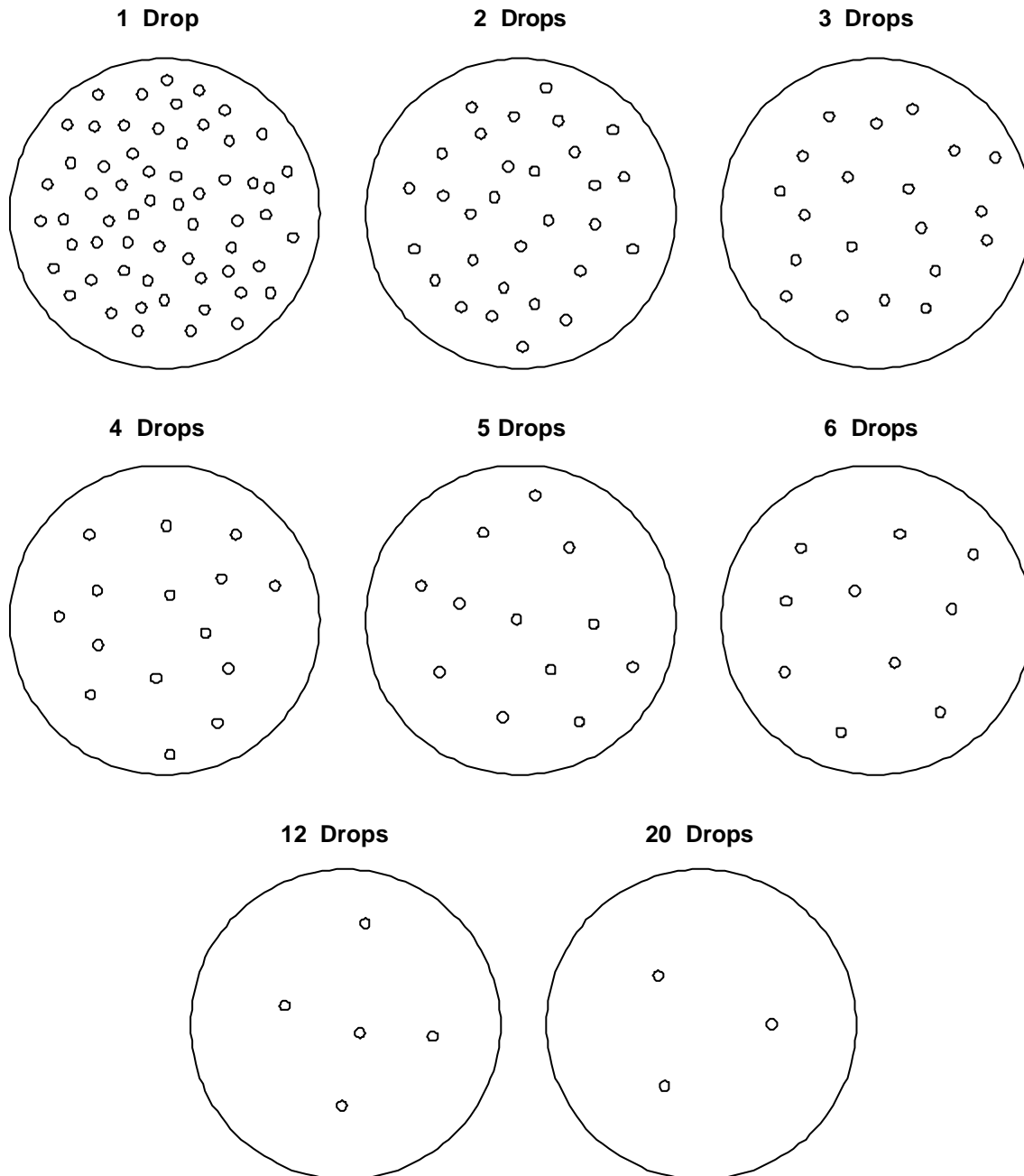

CELLS/40X FIELD AS A GUIDELINE TO THE NUMBER OF DROPS OF CELL SUSPENSION/CYTOSPIN SAMPLE CHAMBER

APPENDIX 1 - METHODOLOGY GUIDELINES

will determine the size centrifuge tubes which will be necessary. In some cases, the original specimen may need to be split between many tubes. As an example, if a centrifuge is available which can hold 50 ml tubes, and the total amount of specimen is 100 ml or less, then two tubes can concentrate the entire specimen. Should the specimen amount to 150 ml, then four tubes would be required. Remember, centrifugation will also require equal numbers of tubes. By adding more tubes it is possible to concentrate specimens which are quite large in volume. To sediment the cells, the centrifuge should be spun at 2000 to 3000 r.p.m. for 10 to 20 minutes. Avoid spinning at excessive speeds. This will only damage cells, and pack them into such tight buttons they will be difficult to process further. Centrifuges with swinging buckets will generally require slightly higher speeds than angle headed centrifuges.

After conventional centrifugation, any cells present in the sample would appear as a packed button in the bottom of the tube. The clear supernatant above the cell button should be carefully aspirated and poured off, leaving a volume of fluid approximately equal to the volume of the packed cell button.

The fluid that is aspirated or poured off may be discarded, using any common technique to render it harmless (sterilisation, fixation etc.). This fluid should only be discarded after it is determined that the cells within have indeed been retained.

The packed cell button in the bottom of the centrifuge tube should be thoroughly mixed with the residual fluid which was not removed. This is done either by use of a vortex mixer, or by gentle agitation of the tube. The result is a concentrated cell suspension, suitable for cell number determination, and subsequent preparation with the Cytospin.

d Specimen Dilution

Cytology specimens often are submitted to the laboratory with a cell concentration that is too high for Cytospin preparations until diluted. Such specimens are common from bone marrow, lymphoid aspirates, and many fine needle aspirates. These concentrated specimens should first be evaluated for cell number, using any of the previously described techniques. The specimen should then be diluted to an approximate cell concentration by addition of a balanced electrolyte

solution. It is important to use a fluid that has a proper osmolarity, in order not to introduce structural changes in the cell sample. Simple solutions of Sodium Chloride (0.9% saline) are unsuitable as diluents - they produce rapid changes in nuclear chromatin and interfere with subsequent cytological evaluation.

Suitable diluents are those commonly used in hematology laboratories, such as Polysal, Polyonic R-148, Plasma-Lyte, Isoton, Tisu-u-Sol, or Normosol. Many of the solutions commonly used in tissue culture laboratories are also suitable diluents, such as Gey's balanced salt solution, Earle's balanced salt solution, or Hank's balanced salt solution. In many cases, if the cell suspension submitted to the laboratory has been collected in one of these diluents, or has undergone significant processing in such salt solutions, it may be advisable to add some protein to the diluent. Either human serum or a solution of bovine serum albumin may be used. The usual concentration of these solutions is 1 to 30 percent. The protein solutions of very high concentration are usually used by dropwise addition to the sample just prior to or during loading of the Cytospin funnels.

e Loading the Cytospin Sample Chambers

The sample chambers hold a maximum of 0.5 ml of specimen and should hold no less than 0.1 ml. It is mandatory that no more than 0.5 ml of sample is placed in each sample chamber. Additional sample would simply be thrown to the top of the chamber during Cytospin operation, and could not be deposited on the slide. It is recommended to load the sample chambers after they have been assembled and inserted into the sealed head. The design of the chamber assemblies and the sealed head ensures that the sample chambers tilt in such a manner that the specimen will not contact the slide or the filter card prior to starting the Cytospin. The specimen must **never** contact the slide or filter before the Cytospin is started. The operator must be careful during loading not to forcibly inject the sample into the sample chamber. The sample should be eased into the sample chamber slowly, allowing ample opportunity for air to be displaced by the sample. Cytofunnel™ disposable sample chambers are available for added safety and convenience.

APPENDIX 1 - METHODOLOGY GUIDELINES

For concentrated cell suspensions which require only one or two drops of sample to obtain the correct cell concentration, it may be sometimes necessary to add additional diluent to bring the total volume in the sample chamber up to 0.5 ml. This addition can be done in the chamber as the samples are loaded. However, this requires care to avoid forcing sample into the slide/filter area and it is recommended that 'thick' specimens are diluted prior to being loaded into the Cytospin.

During loading of the sample chamber, the sample should be deposited directly in the bottom of the sample chamber. Avoid dripping the sample down the side of the sample chamber. Should sample be deposited on the walls of the chamber, rinse down with a drop of diluent. The object is to ensure that all of the sample is in the bottom of the sample chamber.

f Selecting Time and Speed for the Cytospin

The speed of operation of the Cytospin is dependant on the size of the cells or particles to be deposited on the slides. In general, average cellular specimens will require a speed of approximately 1000 r.p.m. Very large cells and fragile cells may require a slower speed, such as 500 to 800 r.p.m. Specimens consisting of tiny objects such as bacteria may require much higher speeds, approaching 2000 r.p.m.

Time of Cytospin operation is also related to specimen type and to subsequent preparative steps. For most cytological preparations, it is desirable to avoid any possibility of air drying of the specimen. Therefore the time used for Cytospin operation is kept as short as possible, such as 3 to 4 minutes. For hematology and microbiology specimens which often are air dried prior to further processing, a longer time is used, often approaching ten minutes.

An appropriate Cytospin time will ensure fluid absorption. The cells on the slide should have a thin layer of fluid on their surfaces. Occasional specimens may be too thick to completely absorb in the filter paper during a normal time and speed setting. Such specimens may require special processing. An example is joint aspirations which contain hyaluronic acid, giving them a thick consistency. This can be reduced by adding a small amount of the enzyme hyaluronidase to the sample prior to operation of the cytocentrifuge.

g Unloading the Sample Chambers

After the Cytospin stops, the specimens should be removed as quickly as possible. The lid of the Cytospin is opened, and the sealed rotor is removed and taken to the biological safety cabinet. The lid is opened, and the individual sample chamber assemblies are removed from the rotor. For cytology specimens, the assemblies are laid on flat towelling, and the clips released. The chamber assembly is lifted straight up on occasions where liquid remains, allowing any residual fluid to flood the slide. If there is a considerable amount of residual fluid, wait until some of it evaporates. However, do not allow the specimen to dry. Just before drying begins, place the slide in fixative, or spray with Cell-Fixx™.

For specimens which do not contain excess fluid, quickly remove the sample chamber, remove the slide, and immediately place into fixative. (This is best achieved by easing the slide into the fixative, so as not to disturb the deposited cells).

Specimens intended for air drying techniques, such as hematology specimens and some microbiology specimens, are handled somewhat differently. In these specimens, it is undesirable to have residual fluids flood the slide. The chamber assemblies are stood upright on the towelling prior to unclamping. Then the clips are released and the chamber pulled away from the slide. Residual fluid is retained in the sample chamber, and does not flood over the deposited cells. The slides resulting from this procedure are then completely air dried prior to further processing.

h Evaluation of Specimen to Assess Technique

After staining, the specimens can be evaluated to assess the preparative technique.

The ideal result is a monolayer of cells with minimal overlap, yet sufficiently concentrated that one does not have to search for cells in the preparation. The cells should display excellent morphology. There should be no evidence of stretching, or tearing of the periphery of cells. Such artefacts indicate excessive speeds or times of cytocentrifugation. In excellent

APPENDIX 1 - METHODOLOGY GUIDELINES

preparations, there will be flattened nuclei with distinct chromatin patterns. Some cell types, such as columnar epithelial cells should retain their typical columnar morphology. Distortion of their columnar shape indicates excessive speed or time of cytocentrifugation.

Occasionally one will see a specimen that has a pattern of cell deposition around the periphery of the deposition spot, with a loss of cell in the center. This effect is due to an excess amount of residual fluid in the center of the cell deposition area when the specimen is fixed. Because the cells in the center of the area are quite wet, they wash off the slide as it is immersed into the fixative. The solution to this problem is to allow longer time for the slide to dry prior to fixation, and to be exceptionally gentle during immersion of the slide into the fixative.

j Fixation

Fixation is used to preserve cell samples, to render them more easily stained, and to produce characteristic patterns of cell structure which are used to distinguish cell types. Cells continue their natural living processes after being removed from body sites. Since they no longer have their normal blood supply and other supporting environment, they will begin to degenerate as they run out of required nutrients and gases and begin to build up waste products. As these events continue, the cell activates internal repair mechanisms that eventually result in the cell digesting itself. This is called autolysis. The rate at which autolysis progresses is different for different cell types, but does mean that samples should be processed as quickly as possible. Autolysis can be slowed significantly by refrigeration, and samples may be held for some period of time at refrigerator temperature. Where practical however, specimens should be fixed or processed as soon as possible.

Fixatives are chemical agents that both kill the cell and stabilize its structure. The 'killing' also inactivates many of the enzyme systems of the cell, particularly those associated with autolysis. Fixatives therefore also function as preservatives, and well fixed cytological samples essentially last indefinitely. Many specific chemicals can be used as fixatives, and each has specific properties that are desirable for certain types of study. These fixatives include those that produce

chemical cross-links within the tissues, such as formalin, and those that precipitate cellular components such as the alcohols. By far the most common fixative used in cytological studies is alcohol. Alcohol produces distinct nuclear chromatin patterns, and also serves to remove water from the cells. Cell-Fixx spray fixative is an example of an alcohol based cytological fixative which also contains Carbowax (Carbowax is a registered trade name of Union Carbide).

A disadvantage of alcohol fixatives is that they evaporate quickly, and therefore there is always the risk of permitting specimens to dry out. To avoid this, many laboratories use Saccomanno fixative, which is a mixture of 70% ethyl alcohol and 2% Carbowax (polyethylene glycol). The Carbowax in this mixture forms a coating over the specimen, helping protect from the effects of drying. The Carbowax is soluble in water, and so is dissolved in subsequent staining steps. Commercial versions of this fixative are available (Thermo Shandon Cytospin Collection Fluid).

When specimens must be transported over considerable distances, or when they cannot be processed immediately, it is advisable to fix with alcohol or with Saccomanno type fixative. This is done by adding an equal volume of fixative to the sample. If the specimen is large in volume, the sample should be centrifuged to concentrate the cells, and then fixed. Immediately after adding the fixative to the sample, the sample should be vigorously agitated to suspend the sample within the fixative.

Occasionally samples will be received that have been fixed in some other fixative such as formalin. These will have a different nuclear and cytoplasmic appearance if processed without exposure to alcohol. Such specimens can be concentrated, the formalin poured off, and then re suspended in Saccomanno-type fixative. The result will be a specimen that is reasonably similar to those fixed in the alcohol fixative alone.

Fixation makes cells more rigid, and less able to spread when placed in the Cytospin. Specimens that have been fixed prior to depositing on slides will require slightly higher speeds and longer times to achieve the same degree of spreading as seen in unfixed specimens. Occasionally the laboratory will be asked to prepare specimens that have been held in fixative solutions for extended times. These specimens may be so rigid that it is difficult to get them to flatten on the slide. The addition of a small amount of glycerol to

APPENDIX 1 - METHODOLOGY GUIDELINES

the specimen, allowing some 'soak' time, followed by use of the Cytospin, will usually result in a reasonable preparation.

Many laboratories prefer to fix all specimens during preparation. The usual protocol is to concentrate the specimen, then re suspend in an equal volume of Saccomanno-type fixative. For samples that must be diluted, the diluent can be fixative. These fixation steps are generally done just before adding the sample to the Cytospin sample chamber assemblies.

Whether the specimen has been fixed before deposition on slides or not, immediately after removing the slides from the Cytospin, they should be immersed in 95% alcohol to complete fixation and dehydration. Since the cells will still be wet, and will not have become totally bound to the glass slide, use care in this transfer. (Ease the slide into the fixative in the container). Many complaints of poor cell capture can be traced to lack of care in this step of the procedure.

4 **SPECIAL CONSIDERATIONS**

a Cell Adhesion

Successful application of the Cytospin requires that cells adhere to the glass slides. For many routine applications, it is sufficient to use clean slides. Slides may be cleaned using alcohol. The increasing use of long staining techniques, such as immunostaining, may require additional steps to ensure adhesion of samples. Slides may be coated with Poly-L-Lysine (Sigma) or with aminosilane (Sigma). The use of any of these adhesion methods will increase cell retention and reduce the incidence of 'floater' in the subsequent staining baths.

b Cytology

The majority of the procedures previously discussed apply to cytological specimens. However, there are a number of specific specimen types which require special processing. Often, the cytology specimen will contain clots, fibrin webs, or tissue fragments. These

will all interfere with the Cytospin preparations. Small floating clots and fragments, should be removed with forceps. These may be saved for cell block procedures. Fibrin webs are generally too friable to be removed intact. These are most easily removed by twirling a glass or wooden rod in the specimen. The fibrin web is wound onto the rod, and in the process, many of the trapped cells will float free. After winding on the fibrin, it is pressed gently against the side of the container to squeeze out as much of the trapped fluid and cells as possible. As with all cell manipulation techniques, it is important to be gentle to avoid excessive cell damage.

Cytological samples may contain considerable quantities of mucus. This a very thick mass that is difficult to dilute or concentrate, and becomes a rubbery mass on fixation. Such specimens should be processed prior to fixation. A common way to break up mucus is to mix with an equal part of Saccomanno-type fixative and immediately blend in a small blender. Three to five seconds is usually sufficient. The blending procedure should be done in a biological safety cabinet. After blending, the sample should be homogenous and non-stringy, and can be deposited using the Cytospin. Certain chemicals also react with mucus to produce liquefaction, such as acetylcysteine (Boccatto, 1981). A commercial product of this type is Mucollex, which contains not only a mucolytic agent but Saccomanno-type fixative as well.

Bloody or serosanguineous specimens may contain so many erythrocytes that examination of cytological preparations is difficult, and when the specimen is diluted sufficiently to obtain monolayer preparations, the cells of interest are difficult to locate. Red blood cells may be removed by gradient centrifugation or by various lysing procedures. Lysing techniques are commonly used for leukocyte counting on cell counters which employ sensing orifices. A number of commercial lysing reagents are available and provide complete destruction of erythrocytes. Lysing reagents may also damage some cells of cytological interest, and care must be used in their use. The large amounts of hemoglobin released from the red cells may interfere with subsequent staining. It can be removed by several washing steps using a conventional centrifuge.

Gradient centrifugation is based on a density difference between red cells and other cells within a

APPENDIX 1 - METHODOLOGY GUIDELINES

specimen. Commercial gradients are available, and are based on mixtures of Ficoll and Hypaque. The sample is layered onto the gradient in a centrifuge tube and then the tube is centrifuged. The red cells will migrate through the gradient, and will also be hemolyzed. The remaining cells will stay on top of the gradient, and can be removed for subsequent processing.

c Hematology

The primary difference between cytological and hematological preparations is the routine use of dried air preparations in hematology. In most cases, hematology will also have available a specific cell count derived from an electronic volume sensing instrument. This permits a defined solution and allows precise control of cell number on the final Cytospin preparation.

Hematological samples are routinely diluted to obtain samples of the correct cell concentration. The diluent used is commonly one of the balanced salt solutions. It is advisable to add a small quantity of serum albumin (preferably bovine for safety) to the sample to increase adhesion of the cells to the slide, and to avoid the deleterious effects of the high concentration as the diluent evaporates during the drying of the slide.

Since hematology specimens are to be air dried, they should not be flooded with any residual liquid after use of the Cytospin. For hematology, after the chambers are removed from the Cytospin sealed head they are stood upright. This drains any residual fluid back into the sample container. The clips are then removed, and the slide separated from the sample container and filter. The slide is then air dried. As with all air dried preparations, the more rapidly drying occurs, the better. Drying may be accelerated by gentle heating of the slides.

d Urine Specimens

Specimens derived from urine are typically high volume fluids with few cells or particles. These specimens must be concentrated by conventional centrifugation prior to cytological examination. Often urine samples contain particles which are not cellular

but are precipitated phosphate salts. It is often suggested that one can dissolve these particles by acidifying the specimen with a few drops of acetic acid. While this will cause the salts to dissolve, acetic acid is also a classic fixative. It will cause chromatin condensation in the cell nuclei, and will also produce significant cell swelling. Acetic acid is a component of Carnoy's fixative. If acetic acid is used, its effects must be accounted for in subsequent evaluation of the specimen.

e Microbiology

Many microbiology samples are quite similar to cytological samples. They will contain cells and the microbiologist is interested in the association of bacteria or viruses with the cells. The Cytospin can also be used to directly deposit samples of bacteria onto slides. The advantages of this use is that the deposited bacteria are generally more concentrated than after simple smearing, and they are all located in a defined area of the slide. Due to the small size of the bacteria, the Cytospin is generally operated at speeds of 2000 r.p.m. for five to ten minutes.

Many of the techniques used for localization of viruses or bacteria require the use of fixatives other than alcohol based ones. In general, techniques using immunostaining or nucleic acid probes will specify the use of aldehyde fixation, such as formaldehyde (paraformaldehyde) or glutaraldehyde. These do not affect the operation of the Cytospin, since they are applied to the slide after the cells, bacteria, or viruses are deposited on the slide. It is important to use a slide adhesive, preferably Poly-L-Lysine or aminosilane for these preparations.

APPENDIX 1 - METHODOLOGY GUIDELINES

THE USE OF THE CYTOSPIN FOR HEMATOLOGY AND OTHER CLINICAL MICROSCOPY SPECIMENS.

a Introduction

This section is designed to provide general guidelines for the use of the Cytospin in hematology and clinical microscopy.

b Uses and Applications

The Cytospin has a wide range of applications in clinical microscopy, some of which are shown below.

USES	CLINICAL APPLICATIONS
1 Romanowsky-stained cytology of CSF and other body fluids.	Evaluation of possible infection or presence of malignancy.
2 Gram stain and other special stains of CSF and body fluids.	Detection of infectious agents: characterization of malignant cells.
3 Slide preparation from ficoll-hypaque cell isolates.	Provides slides for morphology, cytochemical staining (e.g. myeloperoxidase, non-specific esterase), and immunocytochemical or immunofluorescent assays (e.g. TdT). Used to characterize leukemias and lymphomas.
4 Cell surface and cytoplasmic marker studies using monoclonal antibodies.	Classification of leukemias and lymphomas.
5 Urine eosinophis.	Evaluation of drug-induced nephritis, allergic cystitis, and renal transplant rejection.
6 Urine hemosiderin.	Confirmation of severe intravascular hemolysis and chronic iron overload.

c Methodology Guidelines

When first setting up the Cytospin for use, it is helpful to establish a standard procedure, i.e. the amount of specimen/slide, r.p.m. and minutes centrifuged, and maximum number of white blood cells/il and red blood cells/il, above which dilutions would be necessary.

- 1 Determine the red cell and white cell count of the sample according to established methods.
- 2 Using a 'standard' amount of specimen, (e.g. 5 drops or approximately 0.25 ml) make serial dilutions of a highly cellular specimen to determine the maximum number of white blood cells and red blood cells that can be present in a specimen before dilutions are necessary. Some tests may require more cellular slides than others.
- 3 Experiment with a range of r.p.m. to see which gives the most desirable morphology for the procedure involved. Establish the minimum number of minutes required to spin the entire standard amount of

specimen onto the slide. Experiment with the 'high' and 'low' acceleration settings to see if there is any difference in morphology on the cells.

- 4 The following is an example of a standard procedure for preparing slides for a white cell differential with Wright stain:

Use 5 drops of specimen/Cytospin chamber. Dilute sample to obtain a white cell count less than 500/il and a red cell count less than 5,000/il. Centrifuge at 700 r.p.m. for 5 minutes.

Dilution Chart for WBC Dilution

WBC COUNT	DILUTION
0 - 500	None
501 - 1000	1/2
1001 - 1500	1/3
1501 - 2000	1/4
2001 - 2500	1/5
2501 - 3000	1/6

APPENDIX 1 - METHODOLOGY GUIDELINES

If the red cell count which results from the above WBC dilution is greater than 5,000/il, calculate the further dilution necessary to bring the red cell count below 5,000/il. Use this dilution regardless of the fact that the white cell count may be very low.

- 5 Assemble the sample chamber as per the instructions in the Operator Guide. Be sure to align the outlet hole of the sample chamber exactly inside of the hole in the filter card. The edge of the sample chamber must not touch the sample card or the cell yield will be greatly reduced.
- 6 Always place the clip assembly into the Cytospin head before adding anything to the sample chamber. Check that the assembly pivots freely in the metal support plate.
- 7 Add one drop of 30% albumin to the bottom of the sample chamber, then add the standard amount of diluted fluid. Cap the sample chambers. The albumin helps to preserve the cells and keep them in contact as they are deposited onto the slide. (Note: albumin may quench fluorescence and should not be used when immunofluorescent assays are to be performed).
- 8 Lock the lid down on the base, transfer the sealed head to the Cytospin, and close and lock the lid. Never snap the lid of the Cytospin head down onto the bowl while the assembly is sitting on the drive shaft, as this may damage the shaft.
- 9 Program the Cytospin to the standard number of r.p.m. and minutes and start the unit. Fragile cells may require a lower r.p.m. setting and low acceleration to maintain morphology.
- 10 When the alarm has ended, remove the sealed head and transfer it to a hood before opening.
- 11 Check the sample chambers to see if all of the specimen has spun onto the slide. Make sure that any remaining specimen in the chamber does not flow onto the slide as it is removed from the clip. Should this occur, the cells will not remain spread out on the slide and may therefore overstain.

d Suggestions for Optimal Cytospin Technique

- 1 Use one drop of 30% albumin at the bottom of the Cytospin chamber.
- 2 Do not make a push smear, even when the cell counts are high. Large malignant cells are difficult to identify on push smears because they may aggregate at the feather edge or stain darkly in the thick portion of the smear.
- 3 Centre the outlet port of the sample chamber exactly inside of the hole in the filter card.
- 4 Do not let unspun specimen wet the slide when the chamber is disassembled.
- 5 If fibrin strands or other contaminated materials are present, they may clog the filter card and prevent absorption of the specimen. Better slides may sometimes be obtained if an aliquot of the specimen is first diluted in saline, centrifuged, and then the cells are re suspended in saline to the original volume.
- 6 If synovial fluid is extremely viscous, a small amount of hyaluronidase may be added to liquefy the sample before processing.
- 7 If a fluid is clotted, Cytospin slides may be prepared from a suspension of the clotted material as well as from the un clotted fluid to increase the possibility of detecting malignant cells.
- 8 Avoid bacterial contamination of the albumin or saline diluent. Report the presence of bacteria on the slides only when they are also present in neutrophils. Make sure that slides prepared with reagent only are free of bacteria.

These guidelines outlining the Use of the Cytospin for Hematology and other Clinical Microscopy Specimens have been graciously prepared by:

Nicky Sherwood, MT (ASCP)
and
Joanne Cornbleet (MD)

**Clinical Hematology Laboratory
Stanford University Medical Center.**

PRODUCT RETURN SAFETY DECLARATION

Part 1 DECONTAMINATION CERTIFICATE

Any instrument or part of any instrument **must be clean before being returned, and where necessary accompanied by a completed Decontamination Certificate**. Should the instrument or any part of it be received in an unclean condition, or Thermo Shandon Limited consider it to be a hazard, the instrument or part will be returned unrepaired at the expense of the customer.

It is important that the certificate is forwarded by post or fax, and a copy attached to the exterior of the container. Containers will not be opened until the company is in possession of the required certificate.

This form MUST be completed by the customer and NOT a Thermo Shandon or distributor employee.

If an instrument or part is to be returned to **THERMO SHANDON LIMITED**, please note the following:-

- 1 If the instrument or any part of it has been exposed to, or been in contact with potential pathogenic or radioactive material, it is essential that it is decontaminated.
- 2 Set procedures are laid down in the European Health and Safety Directives for decontamination. To avoid any misunderstanding, we request that all instruments or parts returned to us must be accompanied by a certificate stating the following:

We certify that this (Model) Serial No

- has not been exposed to pathogenic, radioactive or other hazardous material and has been cleaned, **OR**
- has been decontaminated and cleaned (if exposed to the above) according to approved procedures, following exposure to:
.....

• Has the instrument been used for work with human, or animal, Transmissible Spongiform Encephalopathies, e.g. Creutzfeld-Jacob disease, Scrapie or BSE?

YES / NO

If yes, please contact Thermo Shandon Service before taking any further action.

Signed Position

Name (Block Capitals)

Company or Organisation

Full address

Part 2 Guidelines for Returning Instruments

Please use the checklist below to ensure that the instrument being returned is ready for collection.

- All reagents / wax removed from instrument, including vapour traps (if applicable)
- Accessories are secured / itemised
- Instrument has had transit clamps fitted as per operator guide
- Instrument is packed in original packaging **YES / NO**

RMA NUMBER

CARRIER

FOR ATTENTION OF

